

THE

DRIP LINE

VOL. 21

NUMBER 4 JANUARY 1998

**BEST WISHES TO EACH PPCC MEMBER
*1998***

Happy Holidays



A Publication of:

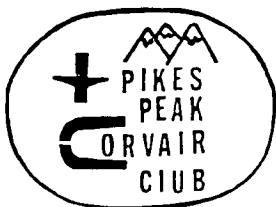

The next meeting of PPCC
is January 28, 1998
at the NCOA Clubhouse

Video of PALM SPRINGS
GWFBT & SM 1997

A Chapter of:



PIKES PEAK CORVAIR CLUB
OFFICERS 1998

PRESIDENT
VICE PRESIDENT
SECRETARY
TREASURER
DRIP LINE EDITOR
MEMBERSHIP

LARRY NEAL
GARRIE FOX
RUTH GOODMAN
JOHN KOLL
STEVE GOODMAN
BEN BENZEL

570-9694
596-5051
(303) 934-5027
593-1928
(303) 934-5027
598-6886

All correspondence To PIKES PEAK CORVAIR CLUB or it's officers should be mailed to PO Box 15034, Colorado Springs, Colo. 80935.

The DRIPLINE is a monthly publication of the PIKES PEAK CORVAIR CLUB, a non-profit organization. Deadline for submitting information to the DRIPLINE is the first Tuesday of each month for that month's publication.

Business card size ads, advertising business services of both members or non-members are \$2.50 per month. To save time and money, advertisers are asked to send \$15.00 for six (6) months or \$30.00 for one year of advertising. Send your advertising check to PIKES PEAK CORVAIR CLUB, INC. PO BOX 15034, COLORADO SPRINGS, COLO. 80935.

Simple classified advertising of CARS FOR SALE or PARTS FOR SALE or WANTED are free to members, non-members will be charged \$2.50 per issue.

PRESIDENT'S NOTES

Well, here we are in a new year. Seems like 1997 was just getting started and WHAM, 1998. I'd like to say thank you everyone who made our club happen last year: first our members, without you we wouldn't have a club! Next the officers and people who run the club: Garrie Fox, VP-John Koll, TREASURER-Ruth Goodman, SECRETARY-Steve Goodman, EDITOR-and of course Ben Benzel, MEMBERSHIP CO-ORDINATOR. **THANKS** to all of you for a great 1997.

I started my new year off right with a drive up to Estes Park for a brunch with RMC. Very enjoyable get-together, thanks RMC. Nice drive too, my NEW 64 coupe buzzed right up and back.

Let's all start off the new year by attending the next meeting and viewing Steve Goodmans' video of the '97 Fan Belt Toss. From what I've seen and heard it was another great TOSS.

Well, **HAPPY NEW YEAR! SEE YOU AT THE MEETING!!!**

Larry

MEETING NOTES

The December 1997 meeting of PPCC was held at the *COUNTY LINE RESTAURANT* on 12/17/97. Dinner was served at 7:00pm by LISA. By 8:00pm dinner was finished and a short meeting/elections were held. The floor was opened for nominations but none were heard, the officers from 1997 will be at the helm in 1998 also. One new member was present, Richard Kennedy, recruited by Garrie Fox. He has a couple of CORVAIRS and works for SATURN. Upcoming events were discussed, the TRI-STATE in Lake City the first weekend of June and the fact that RMC has the turn in 1999 plus the annual NEW YEARS DAY DRIVE for brunch held by RMC (Denver). This year the drive is to Estes Park for brunch at the STANLEY HOTEL. All PPCC members are invited to attend. Laura Wilshire, president of RMC has arranged for a photographer to be at the STANLEY and she plans to submit a picture to CORSA.

The evening was finished by the Yankee Gift Exchange and a safe drive home.

Respectfully submitted,
Ruth Goodman, Secretary



DON'T FORGET THE MEETING ON JANUARY 28--VIDEOS TOO!!!

NOTES FROM YOUR EDITOR

Enclosed in this issue of the DRIPLINE is the 1998 club roster. Please note that the roster WILL NOT be sent to any advertiser in the DRIPLINE, only the members. Your editor has tried his best to insure that no mistakes are present but there is always a chance. Please check your name, address and phone #, inform me if there is a mistake. I now have the roster in my computer so if there is a change and/or addition it will not be hard to fix.

As most of you know, PPCC trades newsletters with some other CORVAIR clubs. The BONNEVILLE club has been writing about wanting to take a turn at the TRI-STATE MEET. They should be at Lake City in June with a lot of members.

If there is a tech topic you would like to see in print, let your editor know.

Kusy's

AUTO TRIM

AUTOMOTIVE AND MARINE UPHOLSTERY



BOAT TOPS & COVERS



3116 ILLINOIS
COLORADO SPRINGS, CO

633-8174

MICHAEL KUSY
OWNER

From one Corvair lover to another...

CORVAIRS

by
CREATIVE STITCHES
2710 Cancun Court
Grand Junction, CO 81506
(970) 245-4722

MEMBER of CORSA/TUCSON CORVAIR ASS'N
PIKES PEAK CORVAIR CLUB
e-mail mr-mrsvair@juno.com

GARRIE L. FOX
M.A. RESOURCE MGMT.
BROKER ASSOCIATE
5265 N. Academy Blvd., #3300
Colorado Springs, CO 80918
Office: (719) 548-0400
Fax: (719) 548-9475
Home: (719) 596-5051



HERITAGE REALTORS

S O L D O N C O L O R A D O



FINANCIAL SERVICES

Greg Blanchi
Registered Representative

Investments

- * *Mutual Funds*
- * *Annuities*
- * *IRA's*
- * *Tax Free*
- * *C.D. Alternatives*

Tax Consulting

- * *Business*
- * *Personal*

Life Insurance

- * *Term*
- * *Universal*
- * *Keyman*
- * *Buy / Sell*

Bus: 719-635-7761 WATS 800-366-7935

320 W. Fillmore, Suite 114
Colorado Springs, CO 80907-6065

All Securities Offered Through InterSecurities, Inc.
An Aegon USA Company
Member National Association of Securities Dealers, Inc.
SIPC and SEC Registered Investment Advisor

MEETING IS JANUARY 28 @ 7:30PM--VIDEO OF PALM SPRINGS TOO

NEW YEARS DAY BRUNCH WITH RMC

January 1, 1998 dawned sunshine and cool; perfect day for a drive in the mountains. RMC hosted their annual brunch to start off the new year, this year at the STANLEY HOTEL in Estes Park. PPCC members attending were PPCC president Larry Neal, Laura, Dale and Joan Wilshire, Ben and Vesta Fulcher, Jim and Linda Richards, Ed and Jean Olwine, Don Smith and Steve and Ruth Goodman.

The menu was very good and with the exception of wind, the weather in Estes Park was good. Laura Wilshire (who is also president of RMC) had arranged for some pictures to be taken, her hope was to have them published in the COMMUNIQUE, maybe the cover. Sixteen CORVAIRS were driven to Estes Park between the two clubs.

WITH THE INJURED

Garrie Fox (our VICE PRESIDENT) is recovering from a fall before the Christmas holidays, he broke a heel on his left foot. He is getting around on crutches and attended the 2nd Sunday brunch at the O-Club on January 11. He even drove his CORVAIR which has 4speed trans. Get well soon.

WE'RE YOUR
DISCOUNT
CORVAIR PARTS
FOR THE 90'S AND BEYOND!



SERVICE
SELECTION
SATESFACTION
SIMPLE!

FOR 23 YEARS WE'VE BEEN SUPPLYING CORVAIR OWNERS WITH THE PARTS THEY NEED - ALL AT THE BEST DISCOUNT PRICES! REPRODUCED PARTS, USED PARTS, REBUILDING SERVICES - WE HAVE IT ALL! BEFORE YOU BUY MAKE SURE TO CHECK US OUT - 30 DAY NO-RESTOCKING, ONE YEAR GUARRANTEE ON MOST PARTS AND SERVICES. FAST, SAME DAY SERVICE. ALL MAJOR CREDIT CARDS ACCEPTED. TOLL FREE ORDER NUMBER (1-800-825-8247). GIANT SELECTION!

ORDER OUR GIANT MAIL ORDER CATALOG - THE CORVAIR BOOK - \$5.00 NOW REFLUNDABLE WITH FIRST ORDER OF \$100.00 OR MORE!

ALSO MAKE SURE YOU'RE ON OUR SUBSCRIPTION LIST FOR OUR FREE NEWSLETTER - THE CORVAIR NEWS WE NEED YOUR NAME & ADDRESS!

CORVAIR UNDERGROUND INC
PO BOX 339 DUNDEE, OR 97115
1-503-434-1648 9-5 M-F
FAX 1-503 434-1648
WWW.CORVAIRUNDERGROUND.COM



PPCC PARTY ENDS '97

The COUNTY LINE Restaurant hosted PPCC members to a Christmas party on December 17. The location was found by President Larry Neal and tested by Laura and Joan Wilshire and Steve and Ruth Goodman on their way back from Palm Springs in November.

The menu was very good plus all you can eat and the service was excellent. After eating a short business meeting was held along with election of officers for 1998. There were no new nominations from the floor which meant the officers from 1997 were railroaded (I mean VOLUNTEERED) for another year. There were no discussions of a retirement fund for newsletter editors either.

After the meeting the gift exchange took place. As usual there were a couple of gifts that just couldn't find a resting place. Thanks to Larry Neal for doing the reservation work.

LOOKING FORWARD TO '98

1998 will be another busy year for PPCC members. The upcoming Tri-state in Lake City should be well attended. Also St. Louis is close enough for a lot of members to be able to drive there. On the local scene, we will be able to attend Tour Tejon this year, it will not interfere with the Tri-state. Hopefully there will be a couple of drives also, maybe even a parade. Plus the street show in Buena Vista over the July 4th time period. PPCC members should make an effort to attend some of these functions if possible. The cars are great to look at and the people are always friendly. We especially have a good time in Buena Vista. RMC (Denver) will be hosting the swap meet/picnic at Christy's house in Boulder this year. PPCC members are invited to attend. Also we (PPCC) must host RMC in the Springs for something. Come to the meetings and help decide what we want to do for 1998.

Watch the UPCOMING EVENTS schedule to try and co-ordinate these events with your own busy schedules and see if we can have a few more cars and members in attendance.

Steve Goodman, editor

UPCOMING EVENTS FOR 1998

JANUARY 28-----January meeting of PPCC at the NCOA clubhouse. Time 7:30pm. Video will be shown of SWAP MEET in Palm Springs last November.

FEBRUARY 7-8-----Tri-state swap meet at EXPO hall, stock show complex in Denver. Swap meet is inside, will be held regardless of weather conditions.

FEBRUARY 11-----Second Sunday brunch at O-club. Time 10:00am. Call Ben @ 598-6886 for reservations please. All PPCC club members are welcome.

FEBRUARY 14-15---Super Swap and Show @ Circle Drive Expo Complex. Swap meet/ motorcycle and rod show.

JUNE 5-7-----Tri-state Corvair meet in Lake City, Colo. More info in a couple of months.

JULY 28-AUG 1-----National CORSA convention in St. Louis.

MEMBERSHIP AND DUES

HAPPY NEW YEAR to all of our fine members. I will continue to serve you in 1998 as the clubs' MEMBERSHIP COORDINATOR. The following named good folks have dues **DUE NOW** or are **PAST DUE**. So if your name appears below it is time to get those dues mailed to PPCC, PO Box 15034, Colorado Springs, Colo. 80935. Questions call Ben @ 598-6886.

Jessie Barnett	2/98	John Koll	2/98
CHRIS BIGGS*	11/97	Terry McKenna	1/98
Misty Decker	1/98	JOHN NEAL*	11/97
John Doswell	2/98	DAVID POOL*	11/97
Bob Gilbert	12/97	Ray Schick	2/98
Mark King	12/97	Richard Sierka	1/98
Richard King	1/98	Don Smith	12/97
LAURA WILSHIRE*	11/97	Don Vinson	1/98

***THIS IS YOUR FINAL NOTICE!! Please remit NOW**

Ben Benzel, membership coordinator

WELCOME NEW MEMBERS

We want to give a warm Pikes Peak Corvair welcome to Richard Kennedy and Dale and Joan Wilshire. These folks are proud Corvair owners and we appreciate their membership with our fine club.

Ben Benzel, membership coordinator

COLORADO SPRINGS WORLD ARENA

Our club was part of the *JUST BUILD IT* campaign of this fine arena. When you visit the arena, pat the club tile. It is located in Section P across 16/down 5. PPCC donated \$25.00 to have our name placed on the tile as a community benefit. Have fun and show your support.

Ben Benzel, membership coordinator

OUR PPCC MEMBER IN RIFLE, CO.

PPCC received a Christmas card from Misty Decker. She lives in Rifle, Colorado. Maybe she will be able to attend some of our functions this year. Whether she does or not, **HAPPY HOLIDAYS** to Misty and Jack.

RAFFLE CAR AT ST. LOUIS THIS SUMMER

During the national CORSA convention in St. Louis this summer the host club **SHOW ME** Corvair club will raffle a car. It is a 1966 Monza, Ermine White, It blue interior, 110/4 with A/C. The tickets are \$2.00 each, winner not need to be present to win although the winner must retrieve the car. The convention dates are July 28-Aug 1.

From time to time a failing starter is traced to not enough battery voltage to actuate the solenoid. This is the purple 12 gauge wire from the ignition switch to the solenoid. The cure is an addition solenoid to help 'throw' the maximum voltage from the battery into the GM solenoid. Below is wiring diagram for doing just that. I might add that the automotive wiring companies that build looms for rods etc use this type of 'booster'.

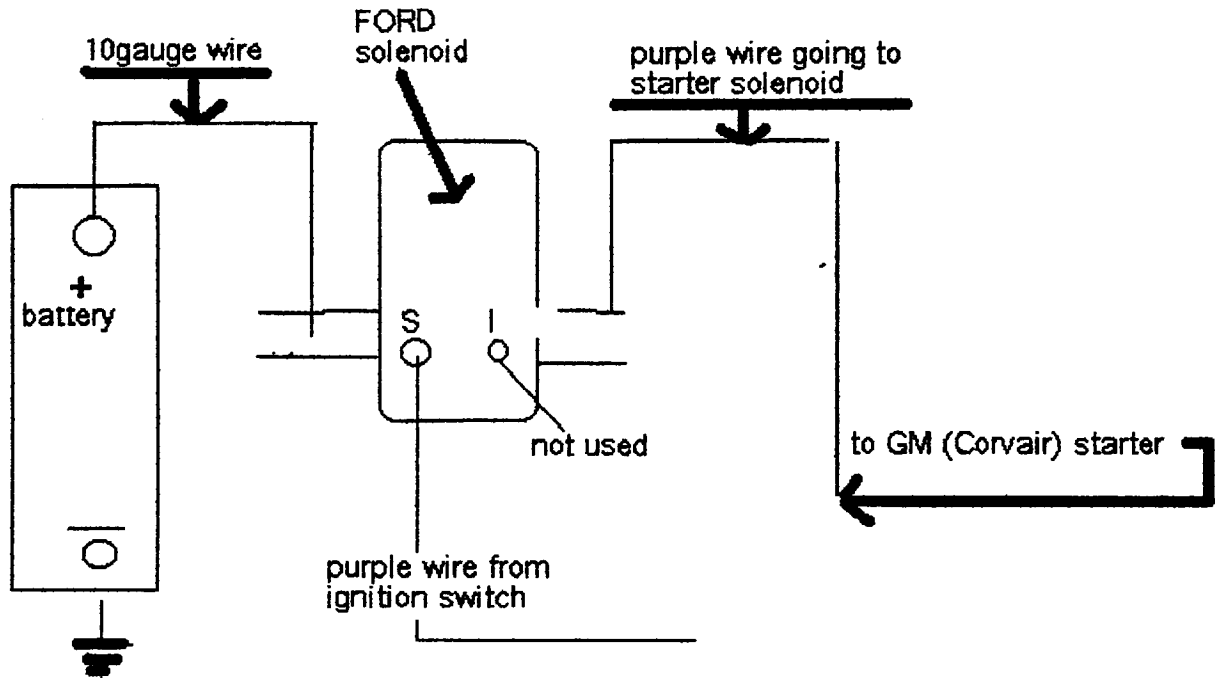

the purple wire coming from the ignition switch to the GM starter solenoid is split apart at the small plug in the engine bay. The wire coming from the switch is attached to the 's' terminal on the FORD solenoid. This wire has the effect of 'throwing the switch' inside the FORD solenoid, connecting the voltage from the battery directly into the GM solenoid.

NOTE: the FORD solenoid MUST BE GROUNDED.

Clark's Corvair Parts, Inc.

Box CC
Shelburne Falls, Ma. 01370

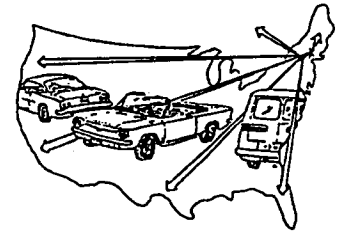

Detailed catalog, technical HELP!

24 years in business and dedicated to the Corvair's future. friendly service clark's - more than parts!

and NOW **NEW** Toll Free 888 * numbers

MAIN PHONE

413-625-9776

MONDAY - FRIDAY
8:30a.m. - 5:00 p.m.
(E.S.T.)

*** ORDER MACHINE**
24 hour

413-625-2558

*** TOLL FREE**
(USA & Canada)

888-267-8247
(888-COR-VAIR)

*** FAX - 24 hour**
413-625-8498

*** TOLL FREE**
(USA & Canada)

888-625-8498

EMAIL - clarks@corvair.com
INTERNET - www.corvair.com



Clark's 3 CATALOG SET

OVER 500 pages,

OVER 3 Lbs.

OVER 14,000 part numbers

\$5 00 in USA Canada \$10.00 (foreign more)

REAR-ENGINE SPECIALISTS
 16010 W. 5th Ave. Unit 12
 Golden, Colo. 80401

Steve Goodman

(303) 278-4889 Fax (303) 936-7420



INTERSTATE BATTERIES

222 East Cucharas
 Colorado Springs, CO 80903
 (719) 577-4548

C. MAX CLARK
 CHUCK CLARK

KEITH CRAIG
 DALE ADAMS



NCOA

Service Center

 3930 Encino Dr.
 Colorado Springs, CO 80918

E.L. "Ben" Benzel
 Senior Master Counsellor

Bus.: (719) 599-9725
 Fax: (719) 540-8387
 Res.: (719) 598-6886



AGENT FOR
ACADEMY LIFE
 A PROVIDIAN Insurance Company

WRECKMASTERS
 BODY & FRAME



Jim J. Keeney
 Owner

315 So. 14th St.
 Colorado Springs, CO 80904
 (14th & Cimarron, H-Way 24)

Bus. 520-1184
 Res. 634-7378

Quality Collision Repair & Painting

THE DRIPLINE
 Pikes Peak Corvair Club
 PO Box 15034
 Colorado Springs, Co.
 80935

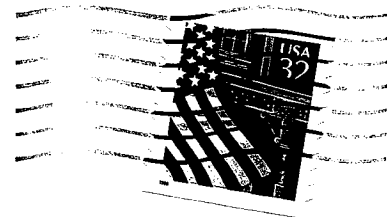

SEND TO:

Walter Hundertmark
 15 El Paso Blvd #26
 Manitou Spgs, Co 80829

80829+2450



THE

DRIP LINE

VOL. 21

NUMBER 4 FEBRUARY 1998

THERE WILL BE A TRIVIA QUIZ AT THE FEBRUARY MEETING

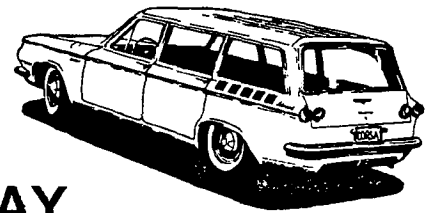
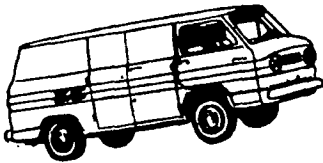

HAPPY VALENTINES DAY

SPRING IS COMING SOON
LET'S GET THOSE CORVAIRS
DUSTED OFF AND READY
TO DRIVE!!!

A Publication of:

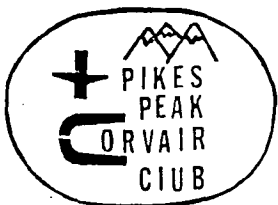

THE NEXT MEETING OF PPCC
IS FEBRUARY 25, 1998
AT THE NOCA CLUBHOUSE

TIME: 7:30PM

A Chapter of:



PIKES PEAK CORVAIR CLUB
OFFICERS 1998

PRESIDENT
VICE PRESIDENT
SECRETARY
TREASURER
DRIP LINE EDITOR
MEMBERSHIP

LARRY NEAL
GARRIE FOX
RUTH GOODMAN
JOHN KOLL
STEVE GOODMAN
BEN BENZEL

570-9694
596-5051
(303) 934-5027
593-1928
(303) 934-5027
598-6886

All correspondence To PIKES PEAK CORVAIR CLUB or it's officers should be mailed to PO Box 15034, Colorado Springs, Colo. 80935.

The DRIPLINE is a monthly publication of the PIKES PEAK CORVAIR CLUB, a non-profit organization. Deadline for submitting information to the DRIPLINE is the first Tuesday of each month for that month's publication.

Business card size ads, advertising business services of both members or non-members are \$2.50 per month. To save time and money, advertisers are asked to send \$15.00 for six (6) months or \$30.00 for one year of advertising. Send your advertising check to PIKES PEAK CORVAIR CLUB, INC. PO BOX 15034, COLORADO SPRINGS, COLO. 80935.

Simple classified advertising of CARS FOR SALE or PARTS FOR SALE or WANTED are free to members, non-members will be charged \$2.50 per issue.

GREETINGS FROM THE PREZ!

A big thanks to Steve Goodman for bringing his video of the ULTRA-VAN meet at Durango as well as the FANBELT TOSS in Palm Springs, Ca. He even got a shot of a DEVIN spider for me!

You might start planning now for TOUR TEJON this year. Since the Tri-state meet is in June we hopefully can attend TOUR TEJON.

Speaking of TRI-STATE, this year it is in Lake City, Co. and sponsored by CNM (Albuquerque). We haven't gotten any specifics yet but should sometime soon.

As always, thanks to our secretary/scribe Ruth Goodman for bringing down an excellent cake and of course for taking notes. Thanks also to everyone who came to our last meeting, it was a pretty good turn-out with a couple of (possible) new members.

Well, that's all for now, see you at the meeting.

Larry

FOR SALE FOR SALE FOR SALE FOR SALE

1960 4DR 3SPD also 1962 station wagon 4spd/spyder engine no turbo, bad piston \$1500.00 takes all

also

1963 Rampside, very good shape

also

1963 Rampside, good shape, Dark Green w/white stripe

also

WANTED WANTED WANTED WANTED WANTED WANTED

1962-64 Monza, auto trans, MUST BE IN TOP SHAPE

For all the above, call Walter H @ 719 685-9495

SOMEONE OUT THERE CARES

Arthur Thompson has been a member of PPCC for some time but let his dues expire. He received a newsletter last month and decided that he still wanted to belong SO he sent a check for \$100.00 to cover 5 years worth of dues and a \$25.00 tip.

Thanks for that, hopefully you can attend some of our events and see where your money goes.

MEETING MINUTES

The January meeting of PPCC was called to order by President Larry Neal at 7:38pm. There were 16 members and 1 guest present. Walter Hundertmark introduced the guest Zack. The treasury report was given, we are building the amount up at last. OLD BUSINESS included discussion of upcoming events such as the Tri-state, Buena Vista and the national in St. Louis. In addition a swap meet is pending in August by the Denver club in Boulder. The swap meet taking place in Penrose on Feb. 14 was noted.

It was brought to the attention of the editor of the DRIPLINE of the misspelling of John Dowsell's last name, it will be corrected in the file. (incidentally the name is spelled correctly on the mailing label, *ed*) It was also noted that BONNEVILLE CORVAIR CLUB in SLC is planning on attending the Lake City event with hopes of hosting the year 2000 event, the place mentioned most is Moab, Ut.

After the door prize drawing and cake furnished by Ruth (thank you RUTH *ed*) Steve showed a video of both the Ultra Van meet in Durango over Labor Day and the Fan Belt Toss in November, both 1997.

Respectfully submitted,
Ruth Goodman, Secretary

Clark's Corvaair Parts, Inc.

Box CC
Shelburne Falls, Ma. 01370

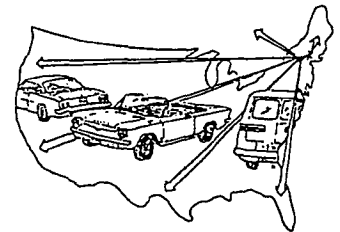

Detailed catalog, technical HELP!

24 years in friendly service
business and dedicated to the
Corvaair's future.

clark's - more than parts!

and NOW



Toll Free 888 * numbers

MAIN PHONE

413-625-9776

MONDAY - FRIDAY
8:30a.m. - 5:00 p.m.
(E.S.T.)

* ORDER MACHINE

24 hour
413-625-2558

* TOLL FREE

(USA & Canada)
888-267-8247
(888-COR-VAIR)

* FAX - 24 hour
413-625-8498

* TOLL FREE

(USA & Canada)
888-625-8498
EMAIL - clarks@corvaair.com
INTERNET - www.corvaair.com

Clark's 3 CATALOG SET

OVER 500 pages,

OVER 3 Lbs.

OVER 14,000 part numbers

\$5.00 in USA Canada \$10.00 (foreign more)

THERE WILL BE A TRIVIA QUIZ AT THE FEBRUARY MEETING

MEMBERSHIP AND DUES

The following named good folks have dues **NOW DUE** or are **PAST DUE**. If your name appears below, it is time to get your money mailed to PPCC, PO BOX 15034, COLORADO SPRINGS, COLO. 80935. Better still, bring that \$15.00 check to the meeting on February 25. Questions call Ben @ 598-6886.

Jessie Barnett	2/98	RICHARD SIERKA*	1/98
MISTY DECKER*	1/98	Dick Shuck	2/98
Walter Hundertmark	3/98	Bob Wencil	2/98
TERRY MC KENNA*	1/98	DON VINSON*	1/98
E. J. OBERMEYER*	12/97	Thomas Pool	3/98
Ray Schick	2/98		

***DENOTES FINAL NOTICE**--In addition the following have not reciprocated and I'm not sure you want to cancel your membership so will give you **ONE MORE CHANCE: CHRIS BRIGGS, BOB GILBERT, DAVE POOL AND DON SMITH. PLEASE RENEW NOW!!**

Ben Benzal, membership chairman

ROSTER CORRECTIONS

The following two names were misspelled in the 1998 ROSTER. The corrected names are as follows: JOHN DOWSWELL AND RAY SCHICK. Your editor apologizes for the errors.

WE'RE YOUR
DISCOUNT
CORVAIR PARTS
FOR THE 90'S AND BEYOND!



SERVICE
SELECTION
SATISFACTION
SIMPLE!

FOR 23 YEARS WE'VE BEEN SUPPLYING CORVAIR OWNERS WITH THE PARTS THEY NEED - ALL AT THE BEST DISCOUNT PRICES! REPRODUCED PARTS, USED PARTS, REBUILDING SERVICES - WE HAVE IT ALL! BEFORE YOU BUY MAKE SURE TO CHECK US OUT - 30 DAY NO-RESTOCKING, ONE YEAR GUARRANTEE ON MOST PARTS AND SERVICES. FAST, SAME DAY SERVICE. ALL MAJOR CREDIT CARDS ACCEPTED. TOLL FREE ORDER NUMBER (1-800-825-8247). GIANT SELECTION!

ORDER OUR GIANT MAIL ORDER CATALOG - THE CORVAIR BOOK - \$5.00 NOW REFUNDABLE WITH FIRST ORDER OF \$100.00 OR MORE!

ALSO MAKE SURE YOU'RE ON OUR SUBSCRIPTION LIST FOR OUR FREE NEWSLETTER - THE CORVAIR NEWS WE NEED YOUR NAME & ADDRESS!

CORVAIR UNDERGROUND INC
PO BOX 339 DUNDEE, OR 97115
1-503-434-1648 9-5 M-F
FAX 1-503 434-1648
WWW.CORVAIRUNDERGROUND.COM

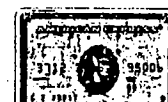

Since two of our members, Garrie Fox and Doug Higgins both have '65 turbo CORSA project cars going, your editor thought it appropriate to include a road test of that car.

If any other PPCC member would like to see a road test of their favorite car let me know. This is reprinted from October 1964 SPORTS CAR GRAPHIC and has to be an early road test for the 1965 model year. SCG is no longer in print so hopefully there will be no repercussions from reprinting this without their permission. (ed)

Although the changes aren't sensational, they do make a great deal of difference!

'65 Corvairs

FOR MANY MONTHS WE'VE LOOKED FORWARD IN ANTICIPATION TO A VIEW OF THE 1965 CORVAIR. As early as December of last year there were rumors from reliable sources that Chevy's air-cooled Compact would undergo its first major styling change. In view of the forthcoming Mustang and other possible sporty-type models from competitors, it was scheduled to have a very definite sports car appearance. We expected something like the Super Spyder show car. Rumor had it that there were two versions under consideration — a tame, tasteful restyle and a really far-out version. Chevy is well-aware that many of its Corvair buyers are extremely interested in sports cars and sports car activities. Small, flexible, economical, and easy to drive, Corvairs number high among the entries at any rally, gymkhana, or slalom. Apparently, Chevy brass got cautious at the last minute and nixed the far-out version, as the heredity of the '65 Corvair is more than obvious. The styling is definitely tame, but entirely successful; it almost completely removes the box-like appearance of previous Corvairs and the hardtop models — the Corsa coupe and the four-door exhibit the beautiful balance and smooth lines of a top-flight European design, if viewed in profile. There's little point in delving further into a description of the body lines; everyone will have full opportunity to see them.

High on the list of things new for Corvair is the full-independent rear suspension. As you know, '64 and earlier models had what might best be described as a semi-swing axle setup. The camber changes were drastic during wheel travel and a definite problem existed where weight-center, roll-center, and camber-change all combined in getting the Corvair around a corner. That setup also had a built-in tendency to wind-wander. At a sacrifice in tire wear, the car could be lowered and a few degrees negative camber cranked in to improve stability and handling, but this was a makeshift correction at best, and had several other drawbacks. What Corvair has adapted is pretty much the Sting Ray rear suspension, where the half-shafts form the upper arm, the lower arm is a single tube, and the trailing torque-arm is a healthy stamping fixed solidly to the hub carrier and pivoting in a large rubber bushing at its forward end.

There are a few innovations all Corvair's own, however. First, due to the 13-inch wheels, it was necessary

to kink the outer end of the lower arms for ground clearance. While camber adjustment on the Sting Ray is accomplished by an eccentric bolt at the inner pivot of this arm, the eccentric is placed at the outer end on the Corvair. As all the arm lengths are shorter in the Corvair, the rubber bushings on the torque arms are more flexible and an additional rod extends transversely from the forward end of the transmission to the pivot end of the torque arm. Threaded adjustment on these rods govern rear-wheel toe-in. Thus, back-end geometry can be adjusted with speed and simplicity. Coil springs are used instead of the Sting Ray transverse-leaf setup.

Next on the list of important news is the Corsa model; an evolution of the Monza Spyder coupe. It's a very smooth-looking hardtop and sports a 180-horsepower Turbocharged engine. The output figure seems to us to be *very* optimistic, but the boost is definitely higher and there are many minor improvements in the turbocharger. An option for the 500 and Monza series is a 140-horsepower engine that sports four single-throat carburetors. All models can be ordered with either three- or four-speed transmissions, but you can't get a Powerglide with the Corsa. Other new options include an adjustable steering column with three-inch travel and a power-top option for the convertible models; both Corsa and Monza.

Brakes are an important item on the new Corvair. They're still drum-type, but are now the same size as the Chevy II and Chevelle (9½-inch diameter), and have 268.6 square inches of swept area. In previous models, it was far from a difficult trick to run them completely out of brakes. There is now plenty of stopping power for almost anything but out-and-out competition.

Our test of the new car took place within the confines of the GM Proving Grounds at Milford, Michigan. They have a small section there known as the Handling Course, very tight and gymkhana-like in the beginning and opening onto a faster series of curves. It provides ample opportunity to evaluate handling potential. We made several laps in a Corsa convertible and a Monza hardtop. Prior to these rides, the best-handling Corvairs we've driven were pretty well doctored with accessories that made them quite stiff and flat. If they swept around a corner at near the limit they did a diagonal dance on the suspension that one Chevy engineer termed "corking." This was especially true if there were any deviations in the road surface. The new Corsa, without any options

or wild camber changes, goes around a corner just as well and without *any* evidence of corking. It is also vastly improved from the standpoint of wind-wander. Steering has been quickened a bit on all models and this, too, is a very desirable improvement. About the only item they left pretty much unchanged is the long throw on the gearshift. The handle has been stiffened, however, and makes the length a lot less noticeable.

Completely docile, the turbocharged engine will, on demand, get the Corsa under way in a hurry, attaining 0-60 mph in 9.7 seconds and holding good acceleration rates right up to its top speed of just under 120 mph. It takes a few rpm to get sufficient charge built up, then the pressure increases constantly and smoothly. Our test took place on a 95°F day; not one you'd imagine conducive to good turbocharger performance, but there was no apparent effect on output and the car started easily after being left standing hot. Good signs of trouble-free motoring.

The body package has been stiffened in many areas to make sure there is no flexibility with the hardtop design. Now included are inner fender wells over the rear wheels. Though it's difficult to accurately judge noise-level im-

provements by ear without an older model right alongside, we'd venture that the new Corvairs are definitely quieter in terms of road and engine noise. They were quite pleasant in this respect and cannot remember being able to say the same in past years; the engine noise was enough to be noticed at all times, and many individual road surfaces produced drumming in the passenger compartment. Some of this was corrected in 1964 and it seems to now be improved below any objectionable level.

As with the Mustang, the Corsa attempts to provide the man that wants a sports car but needs a sedan with an answer. While the Corsa does not offer the super-performance options the Mustang does — when you can get 'em, that is — it is much less a Compact in many ways. Because of current corporate policy, it won't receive the performance image it possibly should, but this won't stop it from being a hot seller. Matter of fact, we feel it's destined to bring an additional amount of head-scratching in Detroit about the potential of a sporty-type car on the market. At least that's the way we hear it. At any rate, the new Corvair is an impressive, enjoyable automobile. Get a test hop in one, even if you aren't in the market for new wheels. — *Jerry Titus*

CHEVROLET CORVAIR CORSA-CONVERTIBLE ROAD TEST 16/64

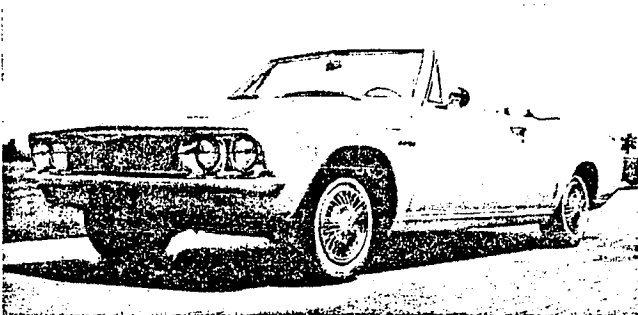

Vehicle Chevrolet Corvair
 Model Corsa Convertible
 Price (as tested) N.A.
 Options Radio

ENGINE:

Type 6-cyl., flat-opposed, air-cooled
 Head Alloy removable
 Valves Ohv, pushrod/rocker, hydraulic lifters
 Max. BHP 180 @ n.a. rpm
 Max. Torque n.a. lbs. ft. @ n.a. rpm
 Bore 3.4375 in. 87 mm
 Stroke 2.94 in. 74.6 mm
 Displacement 164 cu. in. 2685 cc.
 Compression Ratio 8.25 to 1
 Induction System Single-throat, side-draft Carter, turbo-charged
 Exhaust System Two manifolds to turbocharger, single muffler
 Electrical System 12 V. distrib. ignition

CLUTCH:

Single disc, dry, diaphragm plate
 Diameter 9.12 in.
 Actuation Cable

TRANSMISSION:

Four-speed, full-synchro
 Ratios: 1st 3.20 to 1
 2nd 2.19 to 1
 3rd 1.44 to 1
 4th 1.00 to 1

DIFFERENTIAL:

Transaxle, hypoid
 Ratio 3.55 to 1
 Drive Axles (type) Open,
 2-joint half-shafts

BRAKES:

Shoe-type, self-adjusting
 Drum Diameter 9.5 in.
 Swept Area 268.6 sq. in.

CHASSIS:

Frame: Unit construction with sub-frames
 Body: Steel, integral
 Front Suspension: Unequal arm, coil springs, tube shocks, swaybar
 Rear Suspension: I.R.S., single lower, axle upper, trailing torque arm,
 coil springs
 Tire Size & Type: Tubeless 6.40 x 13

WEIGHTS AND MEASURES:

Wheelbase: 108 in.
 Front Track: 55 in.
 Rear Track: 57.2 in.
 Overall Height: 51.5 in.
 Overall Width: 69.7 in.
 Overall Length: 183.3 in.
 Ground Clearance: 5 in.
 Curb Weight: 2665 lbs.
 Test Weight: 2990 lbs.
 Crankcase: 4 qts.
 Cooling System: Air
 Gas Tank: 14 gals.

PERFORMANCE:

0-30	3.1 sec.	0-70	12.3 sec.
0-40	5.0 sec.	0-80	16.8 sec.
0-50	7.2 sec.	0-90	22.7 sec.
0-60	9.7 sec.	0-100	31.9 sec.

Standing ¼ miles 15.6 sec. @ 78 mph
 Top Speed (av. two-way run) 119 mph
 Speed Error 30 40 50 60 70 80 90
 Actual 30 40 50 59 69 78 88

Fuel Consumption N.A. mpg
 Max. 1st 32 mph
 Average: 53 mph
 Max. 2nd 83 mph
 Recommended Shift Points 5500 rpm
 Max. 3rd 83 mph
 RPM Red-line 5500 rpm
 Speed Ranges in gears:

1st	0 to 32 mph	3rd	15 to 83 mph
2nd	8 to 53 mph	4th	22 to top mph

Brake Test: 72 Average % G, over 10 stops. Fade encountered on 7th stop.

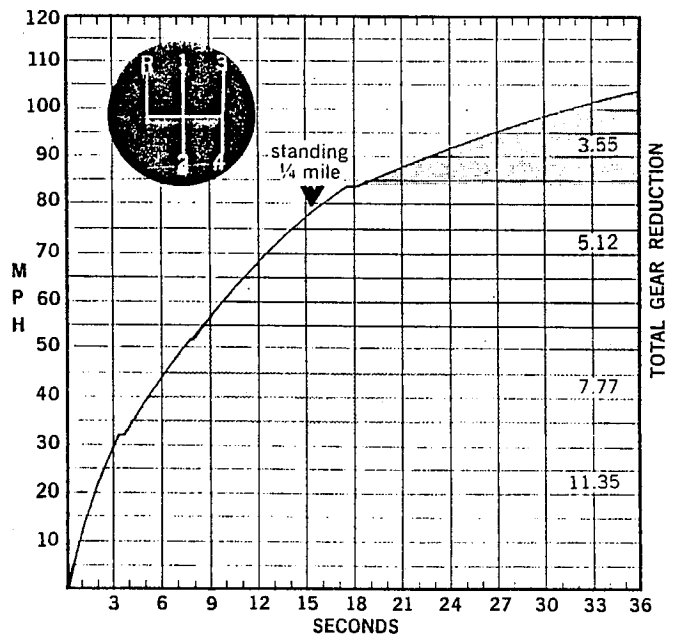

REFERENCE FACTORS:

Bhp per Cubic Inch 1.1
 Lbs. per bhp 16.25
 Piston Speed @ Peak rpm N.A.
 Sq. In. Swept Brake area per Lb. 0.101

THERE WILL BE A TRIVIA QUIZ AT THE FEBRUARY MEETING

UPCOMING EVENTS FOR 1998

FEBRUARY 25-----February meeting of PPCC at the NCOA clubhouse. Time 7:30pm

MARCH 8-----Second Sunday brunch at the O-club. Time 1000am. Please call Ben for reservations @ 598-6886

MARCH 26-29-----41st Annual Tri-state auto exhibition at Currigan Hall, Denver. Entry info call (303) 254-4700

JUNE 5-7-----Tri-state CORVAIR meet in Lake City, Co. Hopefully CNM will send some info soon.

JULY 28-AUG 1-----National CORSA convention in St. Louis, Mo.

Kusy's

AUTO TRIM

AUTOMOTIVE AND MARINE UPHOLSTERY



BOAT TOPS & COVERS



3116 ILLINOIS
COLORADO SPRINGS, CO

633-8174

MICHAEL KUSY
OWNER

From one Corvair lover to another...

CORVAIRS

by
CREATIVE STITCHES
2710 Cancun Court
Grand Junction, CO 81506
(970) 245-4722

MEMBER of CORSA/TUCSON CORVAIR ASS'N
PIKES PEAK CORVAIR CLUB
e-mail mr-mrsvair@juno.com



HERITAGE
REALTORS

GARRIE L. FOX
M.A. RESOURCE MGMT.
BROKER ASSOCIATE
5265 N. Academy Blvd., #3300
Colorado Springs, CO 80918
Office: (719) 548-0400
Fax: (719) 548-9475
Home: (719) 596-5051

S O L D O N C O L O R A D O



FINANCIAL SERVICES

Greg Bianchi
Registered Representative

Investments

- * *Mutual Funds*
- * *Annuities*
- * *IRA's*
- * *Tax Free*
- * *C.D. Alternatives*

Tax Consulting

- * *Business*
- * *Personal*



Life Insurance

- * *Term*
- * *Universal*
- * *Keyman*
- * *Buy / Sell*

Bus: 719-635-7761 WATS 800-366-7935

320 W. Fillmore, Suite 114
Colorado Springs, CO 80907-6065

All Securities Offered Through InterSecurities, Inc.
An Aegon USA Company
Member National Association of Securities Dealers, Inc.
SIPC and SEC Registered Investment Advisor

REAR-ENGINE SPECIALISTS
 16010 W. 5th Ave. Unit 12
 Golden, Colo. 80401

Steve Goodman

(303) 278-4889 Fax (303) 936-7420



INTERSTATE BATTERIES

222 East Cucharas
 Colorado Springs, CO 80903
 (719) 577-4548

C. MAX CLARK
 CHUCK CLARK

KEITH CRAIG
 DALE ADAMS



NCOA

Service Center
 3930 Encino Dr.
 Colorado Springs, CO 80918

E.L. "Ben" Benzel
 Senior Master Counsellor

Bus.: (719) 599-9725
 Fax: (719) 540-8387
 Res.: (719) 598-6886



AGENT FOR
ACADEMY LIFE
 A PROVIDIAN Insurance Company

WRECKMASTERS
 BODY & FRAME



Jim J. Keeney
 Owner

315 So. 14th St.
 Colorado Springs, CO 80904
 (14th & Cimarron, H-Way 24)

Bus. 520-1184
 Res. 634-7378

Quality Collision Repair & Painting

THE DRIPLINE
 Pikes Peak Corvair Club
 PO Box 15034
 Colorado Springs, Co.
 80935

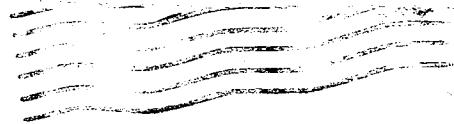

OCR #9 DENVER, CO. 19:25 02/20/98

SEND TO:

Walter Hundertmark
 15 El Paso Blvd #26
 Manitou Spgs, Co 80829

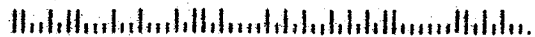

THE

DRIP LINE

VOL. 21

NUMBER 5 MARCH 1998

THE ANNUAL TRI-STATE CORVAIR

MEET IS NEAR

LOOK INSIDE FOR THE HISTORY OF THIS GREAT EVENT

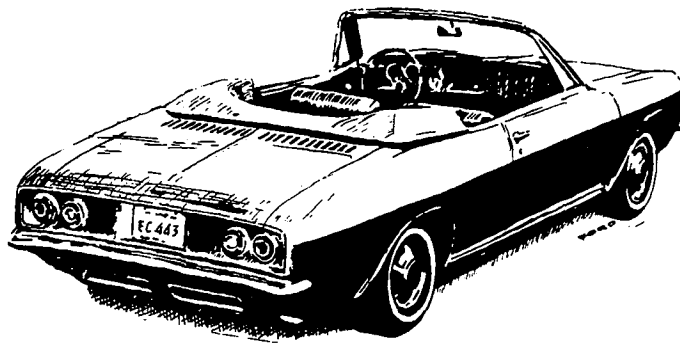

ALSO PLAN FOR TOUR TEJON

A Publication of:



THE NEXT MEETING OF PPCC
IS MARCH 25, 1998
AT THE NCOA CLUBHOUSE

TIME 7:30pm

A Chapter of:



PIKES PEAK CORVAIR CLUB
OFFICERS 1998

PRESIDENT	LARRY NEAL	570-9694
VICE PRESIDENT	GARRIE FOX	596-5051
SECRETARY	RUTH GOODMAN	(303) 934-5027
TREASURER	JOHN KOLL	593-1928
DRIP LINE EDITOR	STEVE GOODMAN	(303) 934-5027
	e-mail rearengine.steve@worldnet.att.net	
MEMBERSHIP	BEN BENZEL	598-6886

All correspondence To PIKES PEAK CORVAIR CLUB or it's officers should be mailed to PO Box 15034, Colorado Springs, Colo. 80935.

The DRIPLINE is a monthly publication of the PIKES PEAK CORVAIR CLUB, a non-profit organization. Deadline for submitting information to the DRIPLINE is the first Tuesday of each month for that month's publication.

Business card size ads, advertising business services of both members or non-members are \$2.50 per month. To save time and money, advertisers are asked to send \$15.00 for six (6) months or \$30.00 for one year of advertising. Send your advertising check to PIKES PEAK CORVAIR CLUB, INC. PO BOX 15034, COLORADO SPRINGS, COLO. 80935.

Simple classified advertising of CARS FOR SALE or PARTS FOR SALE or WANTED are free to members, non-members will be charged \$2.50 per issue.

WORDS FROM THE PRESIDENT

Hello everyone:

Well, we had a pretty good turnout at our February meeting. Everyone seemed to enjoy Steve Goodman's trivia quiz, thank Steve.

We also got the reservation numbers for the tri-state meet in Lake City, Co. Look in this month's DRIPLINE for them. Get your reservations in early! Sounds like we might even start having a <TRI-STATE> event since it is rumored some Salt Lake City folk are planning an event in the future, MOAB maybe.

Since the Tri-state is in June this year, we'll be able to attend TOUR TEJON in May. Start thinking about which car you want to bring.

As always, a big THANK YOU to Ruth Goodman for recording our meeting and bringing the delicious cakes!!

See you at the clubhouse on March 25.

Larry Neal, president

FOR SALE FOR SALE FOR SALE FOR SALE

1960 4DR 3SPD also 1962 station wagon 4spd/spyder engine no turbo, bad piston \$1500.00 takes all

also

1963 Rampside, very good shape

also

1963 Rampside, good shape, Dark Green w/white stripe

also

WANTED WANTED WANTED WANTED WANTED WANTED

1962-64 Monza, auto trans, MUST BE IN TOP SHAPE

For all the above, call Walter H @ 719 685-9495

PARTS FOR SALE

Mark King called your editor a couple of weeks ago about an ad for some of his parts. He was supposed to have gotten it to the POST OFFICE BOX but apparently it did not get there. The basics of his phone conversation was this: Lots of parts for sale, call Mark if you need something, he wants to get these parts into the hands of CORVAIR owners instead of scrapping them. Call Mark @ 392-3834

THE HISTORY OF THE TRI-STATE CORVAIR MEET

In 1976 the national convention was to be held in Philadelphia. This was not an easy drive for those of us on the west side of the USA and added to that was the bi-centennial celebrations that were sure to add to the expense. CORVAIR clubs from Denver, Salt Lake City and Albuquerque decided to hold a small meet in a central location to those three cities and have our own convention. Montrose, Colorado was chosen and as a driving event once there we drove to Ouray falls. We also did a show and shine and the Saturday night banquet was at Mary's. It was intended to be a one time affair.

Fast forward 10 years, Albuquerque revived the gathering with the suggestion that the host responsibilities be rotated much in the same manner as the Fan Belt Toss in Palm Springs. Albuquerque again used Montrose as a central meeting spot. Sadly the Bonneville club did not have any members attending. The next year (1987) RMC took their turn in Ouray. Even though there were no Bonneville members present the newly started PPCC (Colorado Springs) club did show up. The name 'TRI-STATE' stuck albeit with only two states being represented.

PPCC took a turn the next year at Canon City. Bonneville had a couple of members in attendance, they were planning the national the following year. Albuquerque chose Red River, NM for 1989, a small ski resort west of Raton or south of Ft. Garland. RMC picked Durango the next year and had a train ride on the narrow gauge as well.

Gunnison was the choice by PPCC for 1991 then Las Vegas (the one in New Mexico) was the site by Albuquerque in 1992. 1993 saw the meet go to Alamosa hosted by RMC, we even had two members of RMC living there to help. The view from the restaurant at the Pagosa Lodge in Pagosa Springs was what lured PPCC to pick it for 1994. Albuquerque had received such rave reviews of Red River that they chose it again for 1995, and a job well done too because they were the hosts of the national in 1996.

PPCC wanted to try Crested Butte for 1997 but could not make it work. Instead PPCC chose Gunnison again and drove to Crested Butte on a poker run.

That brings us to 1998. Lake City, Colorado is the site by Albuquerque. Lake City is a small town in a valley, the view from anywhere is spectacular as well as the drive to get there. Most of these past years have seen a parade, show and shine, an econo run or poker run, lots of time to enjoy the scenery and the town. The local folks have always been friendly and cordial as has the town leaders and this year should be exactly the same.

There have been only two families that have attended every TRI-STATE meet. They are Steve and Rita Gongora from Albuquerque and Steve and Ruth Goodman from Denver. There is no rivalry there but there is with a traveling attendance trophy. Each year the club with the most members present wins the plaque for that year with their name engraved on it. RMC has won it the most times, CNM next and PPCC will never win it because of their consistent small turn out. In all fairness however, PPCC has the fewest members too.

In addition this year, Bonneville has announced that they will attend in force and hope to take a turn in hosting future TRI-STATE events. According to SLC members they are thinking of Moab for the year 2000. The dates for this year are June 5-7, put these dates on your calendar and drive to Lake City.

Steve Goodman

TRI-STATE ON JUNE 5-7

The following are phone numbers for motel/cabins in Lake City: Town Square 944-2236 (\$45/up per nite)---Silver Spur 944-2231 (\$45/up per nite)---G&M Cabins 944-5055 or 948-5816 (\$50/up per nite). NOTE: all phones are 970 area code. Dinner Saturday nite will be beef, chicken or vegetarian and will probably be in the city armory, about a block from hotels and city park. CNM is planning a parade and show/shine in city park if possible. Dinner costs are anticipated to be are \$15 each. Host motel will be Town Square.

If there are questions, call Steve or e-mail Tarmo Sutt @ tarmo@juno.com

PPCC SUFFERS THE LOSS OF DOROTHY MALEW

We are sorry to learn that Dorothy Malew passed away on March 3 from a major stroke. Dorothy was the editor of the **DRIPLINE** for several years and her cover art is still used occasionally. Her willingness to help will be missed by all. Ed, our heartfelt thoughts are with you and we will share with you this time of sorrow.

Your CORVAIR friends.

MEMBERSHIP AND DUES

The following named PPCC members have dues **NOW DUE** or are **PAST DUE!!** If your name appears below it is time to get your check mailed to PPCC if you can't attend the meeting on March 25. Mail to PPCC PO Box 15034 C Springs, Co. 80935. Our dues are **\$15.00** per year and we appreciate your support. Questions call Ben Benzel @ 598-6886.

Timothy McDonald	4/98	*DICK SHUCK	2/98
*BOB WENCL	2/98	Ed Malew	4/98
Thomas Pool	3/98	Brenda Ramlo	4/98
*RAY SCHICK	2/98		

***DENOTES FINAL NOTICE PLEASE SEND THAT CHECK NOW!!!!**

Ben Benzel, membership chairman

WE'RE YOUR
DISCOUNT
CORVAIR PARTS
FOR THE 90'S AND BEYOND!



SERVICE
SELECTION
SATISFACTION
SIMPLE!

FOR 23 YEARS WE'VE BEEN SUPPLYING CORVAIR OWNERS WITH THE PARTS THEY NEED - ALL AT THE BEST DISCOUNT PRICES! REPRODUCED PARTS, USED PARTS, REBUILDING SERVICES - WE HAVE IT ALL! BEFORE YOU BUY MAKE SURE TO CHECK US OUT - 30 DAY NO-RE STOCKING, ONE YEAR GUARRANTEE ON MOST PARTS AND SERVICES. FAST, SAME DAY SERVICE. ALL MAJOR CREDIT CARDS ACCEPTED. TOLL FREE ORDER NUMBER (1-800-825-8247). GIANT SELECTION!

ORDER OUR GIANT MAIL ORDER CATALOG - THE CORVAIR BOOK - \$5.00 NOW REFUNDABLE WITH FIRST ORDER OF \$100.00 OR MORE!

ALSO MAKE SURE YOU'RE ON OUR SUBSCRIPTION LIST FOR OUR FREE NEWSLETTER - THE CORVAIR NEWS WE NEED YOUR NAME & ADDRESS!

CORVAIR UNDERGROUND INC
PO BOX 339 DUNDEE, OR 97115
1-503-434-1648 9-5 M-F
FAX 1-503 434-1648
WWW.CORVAIRUNDERGROUND.COM



UPCOMING EVENTS FOR 1998

March 25-----March general meeting of PPCC @ NCOA clubhouse starting at 7:30pm
BRING A GUEST OR FRIEND

APRIL 12-----Second Sunday brunch @ O-club. Time 10:00am Please call Ben for reservations--598-6886

APRIL 22-----April general meeting of PPCC @ NCOA clubhouse starting at 7:30pm

APRIL 26-----TOUR to CLASSICAL GAS in Ft. Collins by RMC. PPCC members are invited to attend. Starts at 9:30am at 120th & I-25. Lunch along the way.

MAY 16-----Abbey Car show in Canon City. Watch next month for more info

MAY 17-----TOUR TEJON in C/Springs. Watch next month for more info but plan now!!

JUNE 5-7-----TRI-STATE in Lake City. See this issue for details

Kusy's

AUTO TRIM

AUTOMOTIVE AND MARINE UPHOLSTERY

BOAT TOPS & COVERS

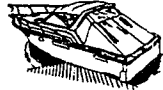

3116 ILLINOIS
COLORADO SPRINGS, CO

633-8174

MICHAEL KUSY
OWNER

From one Corvair lover to another...

CORVAIRS

by

CREATIVE STITCHES

2710 Cancun Court

Grand Junction, CO 81506

(970) 245-4722

MEMBER of CORSA/TUCSON CORVAIR ASS'N

PIKES PEAK CORVAIR CLUB

e-mail mr-mrsvair@juno.com

GARRIE L. FOX
M.A. RESOURCE MGMT.
BROKER ASSOCIATE
5265 N. Academy Blvd., #3300
Colorado Springs, CO 80918
Office: (719) 548-0400
Fax: (719) 548-9475
Home: (719) 596-5051

H

HERITAGE

REALTORS

S O L D O N C O L O R A D O



FINANCIAL SERVICES

Greg Bianchi
Registered Representative

Investments

* *Mutual Funds*

* *Annuities*

* *IRA's*

* *Tax Free*

* *C.D. Alternatives*

Tax Consulting

* *Business*

* *Personal*

Life Insurance

* *Term*

* *Universal*

* *Keyman*

* *Buy / Sell*

Bus: 719-635-7761 WATS 800-366-7935

320 W. Fillmore, Suite 114
Colorado Springs, CO 80907-6065

All Securities Offered Through InterSecurities, Inc.
An Aegon USA Company
Member National Association of Securities Dealers, Inc.
SIPC and SEC Registered Investment Advisor

MEETING MINUTES FOR FEBRUARY

The February meeting of PPCC was called to order by President Larry Neal at 7:35hrs. There were 10 members and one guest present. The guest Gary Romero is an instructor at a local high school shop mechanics class and answered questions about the course and their high school drag race car. The class also has a CORVAIR to restore and show.

Garrie Fox and Larry Neal talked of having a drive in March but no plans were finalized. It was also announced that RMC was doing a garage tour on March 21 and PPCC members were invited.

Steve had phone numbers and other info on the upcoming TRI-STATE meet in Lake City.

A 1964 Spyder was announced for sale, \$6500 but doesn't run properly.

Steve held trivia quiz, Larry got the most correct followed by John and Garrie was 3rd.

Cake was furnished by Ruth, eaten by all. (THANK YOU RUTH ed.) Meeting adjourned at 8:30pm.

Respectfully submitted,
Ruth Goodman, secretary

ADVERTISERS

PPCC members should take note of the new business card advertisement for INTERSTATE BATTERIES. Please attempt to patronize our advertisers, 80 DRIPLINE issues are mailed each month, we should thank our advertisers for their support also.

SUPPORT CORSA ONLY \$35/YEAR TO KEEP OUR HOBBY ALIVE

Clark's Corvair Parts, Inc.

Box CC
Shelburne Falls, Ma. 01370

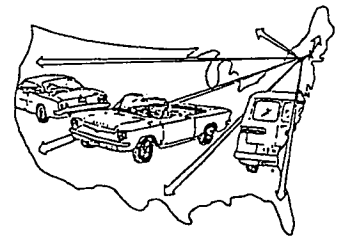

Detailed catalog, technical HELP!

24 years in business and dedicated to the Corvair's future.
friendly service

clark's - more than parts!

and NOW



Toll Free 888 *
numbers

MAIN PHONE

413-625-9776

MONDAY - FRIDAY
8:30a.m. - 5:00 p.m.
(E.S.T.)

* ORDER MACHINE

24 hour
413-625-2558

* TOLL FREE

(USA & Canada)
888-267-8247
(888-COR-VAIR)

* FAX - 24 hour
413-625-8498

* TOLL FREE

(USA & Canada)
888-625-8498

EMAIL - clarks@corvair.com
INTERNET - www.corvair.com

Clark's 3 CATALOG SET

OVER 500 pages,

OVER 3 Lbs.

OVER 14,000 part numbers

\$5.00 in USA Canada \$10.00 (foreign more)

READ THIS BEFORE SELLING YOUR CORVAIR

If you've owned your CORVAIR for a while, you already know the advantages of the car. Such things as superior traction in winter, no hassle with anti-freeze, radiator hoses and etc, easy on tires, brakes, good gas milage, easy to park and on the top of the list 'just plain fun to drive'.

You've also found a few problems, mostly with oil leaks and the necessity for good tires, shocks and alignment. Most of us also know that with some basic and pretty close maintainance these problems can be held to a minimum.

Like any other automobile, the CORVAIR requires tune-ups, oil changes and lube and a general going over to tight and adjust. Remember both the advantages and disadvantages before trading your CORVAIR for one of the new 'economy cars'.

You want to remember too that you are driving an out-of-production model, maybe incorrectly referred to as a classic, but nevertheless a car that will appreciate through the years as long as the car looks and runs good.

What I'm really getting to is the fact that probably your expenditures on your CORVAIR will not exceed and very possibly are less than a combination of the same maintainance costs plus financing and interest and the rapid depreciation of a new car. License plates and insurance are by far cheaper for the CORVAIR.

All in all, I think that a good running CORVAIR will match up with the newer cars. Why don't you the owner take final look at your CORVAIR before trading for something else.

DIFFERENT MEETING IDEAS

It seems that a topic always discussed around tables or Virtual Vair or in other newsletters is the lack of attendance at club meetings. It has always been a given that business meetings are boring and that fact is showing up more and more as the years go along. Most of the club members don't really care how their club runs or what makes it run, they want to do fun and interesting things with their cars.

With that in mind, I gleaned this from CNM's newsletter who had copied it from SDCC. It is not copied word for word but this is the gist of it. SDCC will not discuss business at their regular meetings, excepting for something needing a member vote. All business will be handled at the board of directors meeting. The normal meeting will begin with the program, if there is time left, the traditional approval of minutes, treasurers report and committee reports will have some time. If a member wants to discuss business he must get on the agenda for that discussion.

NOW, after reading that, CNM revised it a bit. Their business meeting will be limited to the 1st 20 minutes unless something very important comes up. The normal business will be conducted at the BOD meeting. CNM reminds all members that they can attend the BOD meeting.

The preface for this article was that Tom Berg, president of SDCC had a conversation with Lon Wall of CORVAIR UNDERGROUND. Lon informed him that his customer base is growing, there are no shortage of CORVAIR owners out there. For a number of reasons they are not joining clubs. Lon also suggested that owners did not find enjoyment in attending a boring business meeting. Lon also stated that the CORVAIR club in his area conducts no business at the regular meeting unless of utmost importance. They do the same thing, programs, tech sessions etc. Lon stated that folks attended their meetings and had fun.



REAR-ENGINE SPECIALISTS
 16010 W. 5th Ave. Unit 12
 Golden, Colo. 80401



Steve Goodman

(303) 278-4889 Fax (303) 936-7420

INTERSTATE BATTERIES
 INTERSTATE BATTERY SYSTEM OF SOUTHERN COLORADO
 222 E. CUCHARRAS • COLORADO SPRINGS CO 80903

C. Max Clark
 Owner/Operator

(719) 577-4548
 FAX (719) 578-8114





Service Center

 3930 Encino Dr.
 Colorado Springs, CO 80918

E.L. "Ben" Benzel
 Senior Master Counsellor

Bus.: (719) 599-9725
 Fax: (719) 540-8387
 Res.: (719) 598-6886

AGENT FOR
 **ACADEMY LIFE**
 A PROVIDIAN Insurance Company

WRECKMASTERS
 BODY & FRAME



Jim J. Keeney
 Owner

315 So. 14th St.
 Colorado Springs, CO 80904
 (14th & Cimarron, H-Way 24)

Bus. 520-1184
 Res. 634-7378

Quality Collision Repair & Painting

THE DRIPLINE
 Pikes Peak Corvair Club
 PO Box 15034
 Colorado Springs, Co.
 80935

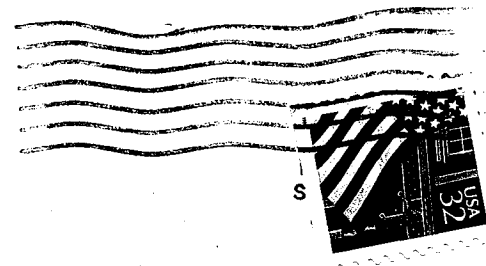

DCR #9 DENVER, CO. 23:49 03/20/98

SEND TO:

Walter Hundertmark
 15 El Paso Blvd #26
 Manitou Spgs, Co 80829

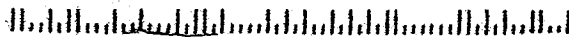

THE

DRIP LINE

VOL. 21

NUMBER 6 APRIL 1998

HAPPY EASTER

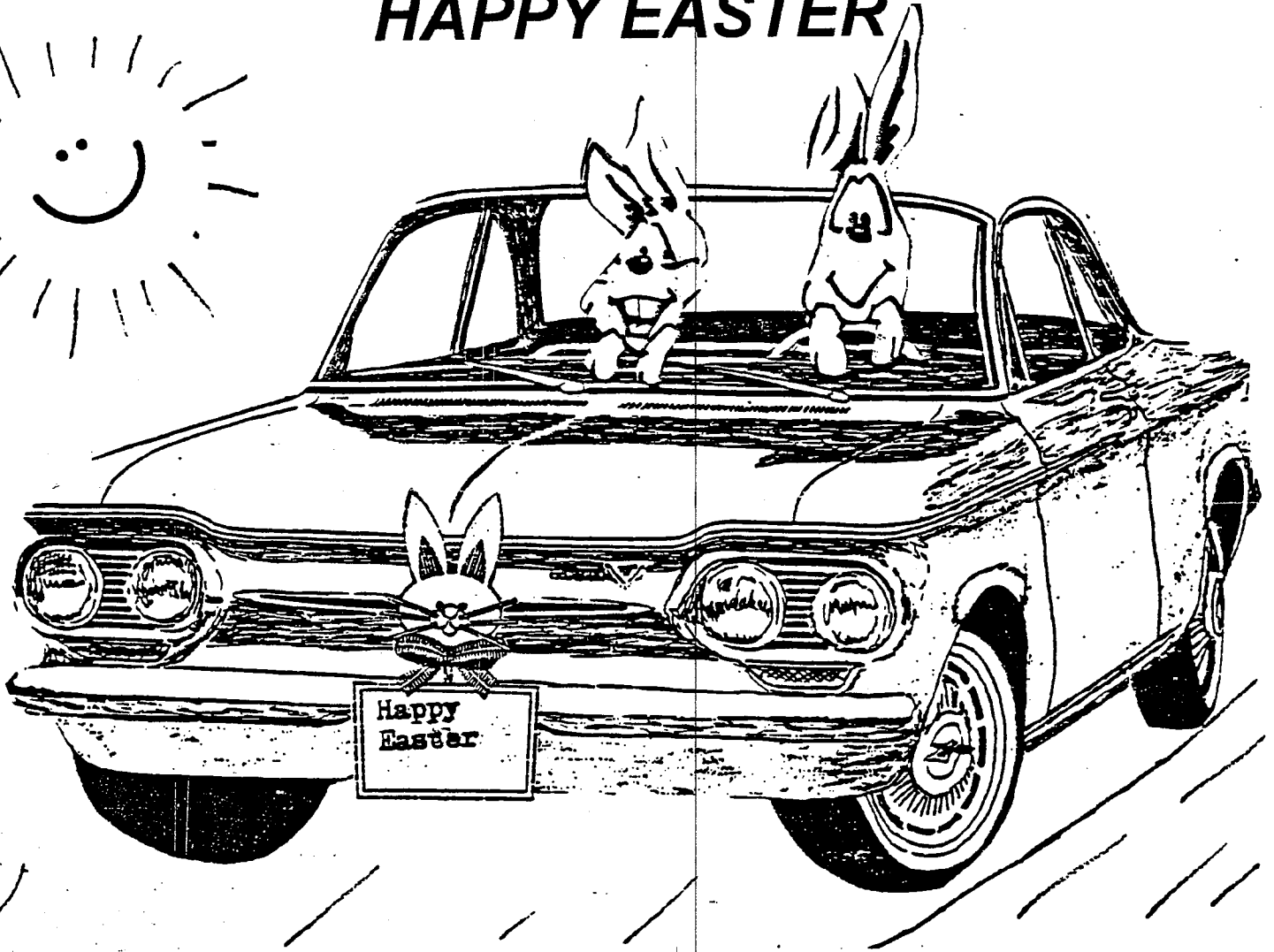
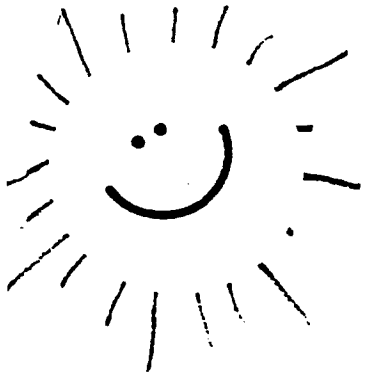

SPRING IS COMING

A Publication of:

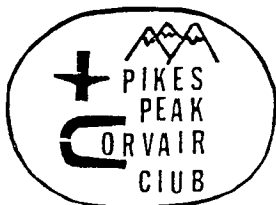

THE NEXT MEETING OF PPCC
IS APRIL 22, 1998
AT THE NCOA CLUBHOUSE

TIME: 7:30pm

A Chapter of:



PIKES PEAK CORVAIR CLUB
OFFICERS 1998

PRESIDENT
VICE PRESIDENT
SECRETARY
TREASURER
DRIP LINE EDITOR

LARRY NEAL 570-9694
GARRIE FOX 596-5051
RUTH GOODMAN (303) 934-5027
JOHN KOLL 593-1928
STEVE GOODMAN (303) 934-5027
e-mail rearengine.steve@worldnet.att.net
BEN BENZEL 598-6886

MEMBERSHIP

All correspondence To PIKES PEAK CORVAIR CLUB or it's officers should be mailed to PO Box 15034, Colorado Springs, Colo. 80935.

The DRIPLINE is a monthly publication of the PIKES PEAK CORVAIR CLUB, a non-profit organization. Deadline for submitting information to the DRIPLINE is the first Tuesday of each month for that month's publication.

Business card size ads, advertising business services of both members or non-members are \$2.50 per month. To save time and money, advertisers are asked to send \$15.00 for six (6) months or \$30.00 for one year of advertising. Send your advertising check to PIKES PEAK CORVAIR CLUB, INC. PO BOX 15034, COLORADO SPRINGS, COLO. 80935.

Simple classified advertising of CARS FOR SALE or PARTS FOR SALE or WANTED are free to members, non-members will be charged \$2.50 per issue.

THE PRESIDENT SPEAKS

Hello everyone!

Well, it's been getting to be warm enough to dust off those summertime CORVAIRS and drive them! Remember to check those brakes, wheel bearings and fluid levels and all the other stuff that dries out over the winter months. Then we'll see you on the road!!

Speaking of 'on the road', remember to make those reservations for the TRI-STATE meet in Lake City on June 5-7. You don't want to wait until the day before to get your room like I did once. I figure I'll only be that lucky once!

We also have TOUR TEJON coming up next month (see calendar of events). We'll have a few CORVAIRS there so I hope to see some of you out and about that weekend.

Next month our monthly brunch get-together will be held at BARONS RESTAURANT on Academy and Airport. Usual time, different place. We thought it would be nice to change the location once in a while. If you want to attend please call me so I can make the proper arrangements.

SEE YOU IN A 'VAIR!

Larry

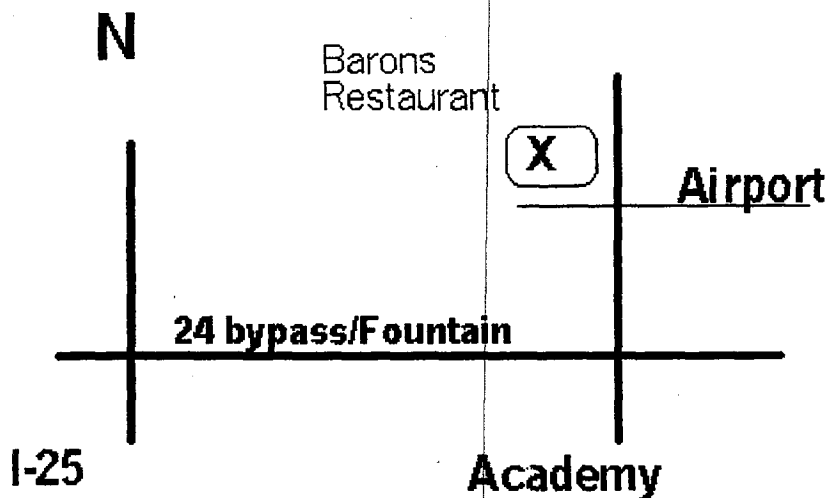

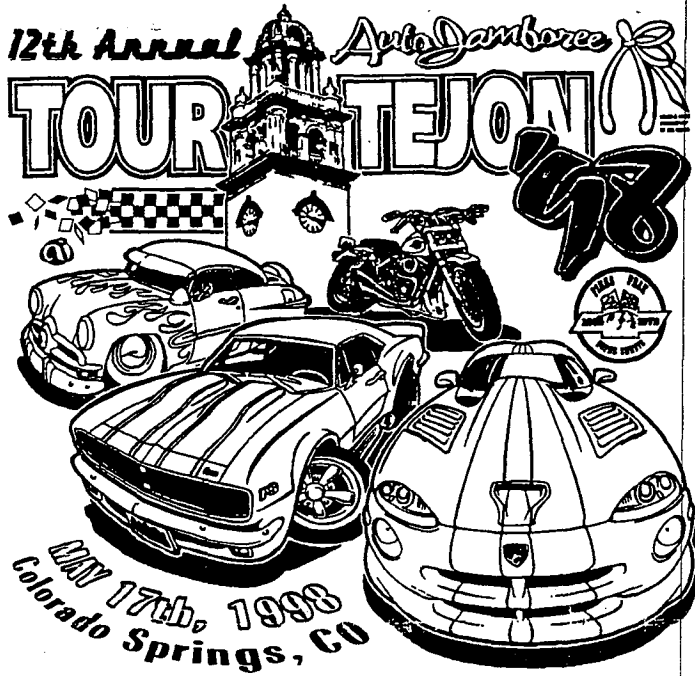

SUNDAY MAY 17th

Street Show & Shine

\$10.00 entry per car before the show

\$15.00 per entry day of show

All Makes - All Models - All Years Welcome

Over 25 classes to choose from,
including, but not limited to:

Custom-Street Rod-Vintage-Mustang-Camaro-
Full Size & Mini Trucks-Competition and
Motorcycle.

Proceeds from this event to benefit

Make-A-Wish Foundation of Colorado

NO LOUD RADIOS OR ALCOHOL ALLOWED ON SHOW GROUNDS

Detach and Return the lower portion

REGISTRATION FORM

I would like to enter the Tour Tejon Auto Jamboree

Name: _____
 Address: _____
 City/State/Zip: _____
 Phone Number: _____
 Make/Model/Year: _____
 Class You Would Like To Enter: _____
(See Attached Page for Classes and Definitions)
 Insurance Co.: _____

Liability Waiver

Applicant agrees to hold harmless Pikes Peak Super Chevy's, it's members and any volunteers from and against any claim which might or does arise out of participation in this event.

Signed _____ (Must have Parent or Guardian sign if Under 18)

Send Check and Entries To:
 Tour Tejon Auto Jamboree
 P.O. Box 6764
 Colorado Springs, CO 80934-6764

MEETING MINUTES

The March meeting of PPCC was held on March 25, 1998. President Larry Neal called the meeting to order at 7:36pm. There were 12 members and 1 child present.

A show of hands for Tour Tejon was requested, Steve, Ben, Gary, Jim?, Laura and family and probably John N if he is in town. Tri-state in Lake City was discussed, CNM is bringing T-shirts for sale.

A motion was made, seconded and voted upon to donate \$25.00 in the name of Dorothy Malew who recently passed away to the Diabetes Association.

President Larry told a little of the garage tour that RMC held and several PPCC members attended on March 14.

Meeting adjourned at 8:25 and door prizes and dessert followed. (*Thanks Ruth for the cakes, ed*).

Respectfully submitted,
Ruth Goodman, secretary

FROM OUR MEMBER IN RIFLE, CO

Misty Decker wrote a short note to **Ben Benzel**, membership chairman and enclosed her dues. She wishes PPCC members well and is hoping to be at the street show at Buena Vista over July 4th. She also announces that her and Jack are getting married later this year and will send the club an invitation. (*good luck, ed*).

WE'RE YOUR
DISCOUNT
CORVAIR PARTS
FOR THE 90'S AND BEYOND!



SERVICE
SELECTION
SATISFACTION
SIMPLE!

FOR 23 YEARS WE'VE BEEN SUPPLYING CORVAIR OWNERS WITH THE PARTS THEY NEED - ALL AT THE BEST DISCOUNT PRICES! REPRODUCED PARTS, USED PARTS, REBUILDING SERVICES - WE HAVE IT ALL! BEFORE YOU BUY MAKE SURE TO CHECK US OUT - 30 DAY NO-RESTOCKING, ONE YEAR GUARRANTEE ON MOST PARTS AND SERVICES. FAST, SAME DAY SERVICE. ALL MAJOR CREDIT CARDS ACCEPTED. TOLL FREE ORDER NUMBER (1-800-825-8247). GIANT SELECTION!

ORDER OUR GIANT MAIL ORDER CATALOG - THE CORVAIR BOOK - \$5.00 NOW REFUNDABLE WITH FIRST ORDER OF \$100.00 OR MORE!

ALSO MAKE SURE YOU'RE ON OUR SUBSCRIPTION LIST FOR OUR FREE NEWSLETTER - THE CORVAIR NEWS WE NEED YOUR NAME & ADDRESS!

CORVAIR UNDERGROUND INC
PO BOX 339 DUNDEE, OR 97115
1-503-434-1648 9-5 M-F
FAX 1-503 434-1648
WWW.CORVAIRUNDERGROUND.COM



GARAGE TOUR IN DENVER

ROCKY MOUNTAIN CORSA held a garage tour in the west side of Denver on March 14. A total of 27 RMC and PPCC members attended. This is the first garage tour in several years.

The tour started at *REAR ENGINE SPECIALISTS* in Golden where there was coffee and a few failed CORVAIR parts on display. Next everyone went around the corner to *POWDER COATING SPECIALISTS* and saw examples of powder coated parts and an informative talk about the virtues of powder coating. From there the group drove to *JACKSONS* for lunch and car talk.

After lunch all drove to PPCC members' *DEAN SCHMIDT*'s home and looked at his 1965 Corsa Convertible, 1965 Corsa w/327 Crown V-8 and a 1956 Bel Air 2dr Hdtp. All are completely restored and very nice. Dean's garage was immaculate as well.

From there the group drove to RMC members Gil and Betty McBride's home. Gil is building a car from scratch using CORVAIR power and he has the frame and running gear finished. The car was driven up and down the street as all looked on. The finished product will resemble a PROWLER according to Gil. Betty furnished drinks and cookies.

PPCC members included Larry and John Neal, Steve Goodman, Dean Schmidt and the Wilshires; Laura, Dale and Joan.

WANTED TO TRADE

1965 FORD MUSTANG hardtop. Will trade straight across for 63-64 CORVAIR convertible. Discuss this with Jan in Kim, Colo. Phone (719) 643-5426

Clark's Corvair Parts, Inc.

Box CC
Shelburne Falls, Ma. 01370

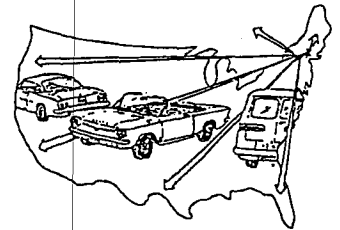

Detailed catalog, technical HELP!

24 years in business and dedicated to the Corvair's future.

friendly service

clark's - more than parts!

and NOW



Toll Free 888 * numbers

MAIN PHONE

413-625-9776

MONDAY - FRIDAY
8:30a.m. - 5:00 p.m.
(E.S.T.)

* ORDER MACHINE

24 hour
413-625-2558

* TOLL FREE

(USA & Canada)
888-267-8247
(888-COR-VAIR)

* FAX - 24 hour
413-625-8498

* TOLL FREE
(USA & Canada)
888-625-8498

EMAIL - clarks@corvair.com
INTERNET - www.corvair.com

Clark's 3 CATALOG SET

OVER 500 pages,

OVER 3 Lbs.

OVER 14,000 part numbers

\$5.00 in USA Canada \$10.00 (foreign more)

MEMBERSHIP & DUES

The following named PPCC members have dues **NOW DUE** or are **PAST DUE!!** If your name appears below it is time to get your check mailed to PPCC if you can't attend the meeting on April 22. Mail to PPCC, PO Box 15034, C/Springs, Colo. 80935. Our dues are \$15.00/year and we need and appreciate your support. Questions call Ben Benzel @ 598-6886.

Del Delaney	5/98	Ed Malew	4/98
Ben Fulcher	5/98	THOMAS POOL*	3/98
John Hesco	5/98	Robert Pride	5/98
Gene Krueger	5/98	Brenda Ramlo	4/98
Bertie McDonald	5/98	Francine Webb	5/98
Timothy McDonald	4/98	James Wilson	5/98

*** DENOTES--THIS IS YOUR FINAL NOTICE AND LAST ISSUE OF THE DRIPLINE PLEASE SEND US THAT CHECK NOW!!!!**

Ben Benzel, membership chairman

WELCOME NEW MEMBERS

Lets' give a warm club welcome to Don & Irmajean Barta who reside in Kansas City, Mo. They are proud owners of a 65 Monza (140) convertible. Your membership in PPCC is compliments of Ken and Judy Brown. Welcome and thanks.

Also Jan Patton has rejoined us after 5 years absence in California. She is happy to be back in Colorado and loves her 64 2dr. She lives in Kim, Co. Good to have you with us again, come and visit the club affairs when possible.

Ben Benzel, membership chairman

TRI-STATE UPDATE

As of this writing the **TOWN SQUARE** motel/cabin in Lake City is filled. The other two motel/cabin places are: **SILVER SPUR**--phone (970) 944-2231 or **G&M CABINS**--phone (970) 944-5055. The prices are \$45-50 and up in each.

Make your reservations quickly, Lake City is a small town and there are no Holiday Inns there. CNM (Albuquerque, New Mexico) the host club is bring t-shirts to the meet, this should be a good souvenir for the weekend. CNM has planned a parade, show and shine and dinner on Saturday night. The area is very scenic and show be great for picture taking.

JOIN CORSA ONLY \$35.00/YEAR TO KEEP OUR CARS ALIVE

UPCOMING EVENTS FOR 1998

- April 22-----April general meeting of PPCC @ NCOA clubhouse starting at 7:30pm
- April 26-----TOUR TO CLASSICAL GAS in Ft. Collins sponsored by RMC. PPCC members are invited to attend. Starts at 9:30am @ 120th & I-25.
Call Steve @ 934/5027 or Laura @ 530-3215 for reservations.
- May 16-----Abbey Car Show in Canon City.
- May 17-----Tour Tejon in C/Springs--entry form in this months DRIPLINE
- June 5-7-----TRI-STATE CORVAIR meet in Lake City.
- July 28-Aug 1-----National CORSA convention in St. Louis, Mo.

Kusy's

AUTO TRIM

AUTOMOTIVE AND MARINE UPHOLSTERY



BOAT TOPS & COVERS

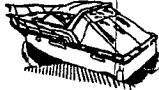

3116 ILLINOIS
COLORADO SPRINGS, CO

633-8174

MICHAEL KUSY
OWNER

From one Corvair lover to another...

CORVAIRS

by

CREATIVE STITCHES
2710 Cancun Court
Grand Junction, CO 81506
(970) 245-4722

MEMBER of CORSA/TUCSON CORVAIR ASS'N
PIKES PEAK CORVAIR CLUB
e-mail mr-mrsvair@juno.com



HERITAGE
REALTORS

GARRIE L. FOX
M.A. RESOURCE MGMT.
BROKER ASSOCIATE
5265 N. Academy Blvd., #3300
Colorado Springs, CO 80918
Office: (719) 548-0400
Fax: (719) 548-9475
Home: (719) 596-5051

SOLD ON COLORADO



FINANCIAL SERVICES

Greg Blanchi
Registered Representative

Investments

- * *Mutual Funds*
- * *Annuities*
- * *IRA's*
- * *Tax Free*
- * *C.D. Alternatives*

Tax Consulting

- * *Business*
- * *Personal*



Life Insurance

- * *Term*
- * *Universal*
- * *Keyman*
- * *Buy / Sell*

Bus: 719-635-7761 WATS 800-366-7935

320 W. Fillmore, Suite 114
Colorado Springs, CO 80907-6065

All Securities Offered Through InterSecurities, Inc.
An Aegon USA Company
Member National Association of Securities Dealers, Inc.
SIPC and SEC Registered Investment Advisor





REAR-ENGINE SPECIALISTS

16010 W. 5th Ave. Unit 12
Golden, Colo. 80401

Steve Goodman

(303) 278-4889 Fax (303) 936-7420



INTERSTATE BATTERY SYSTEM OF SOUTHERN COLORADO
222 E. CUCHARRAS • COLORADO SPRINGS CO 80903

C. Max Clark
Owner/Operator

(719) 577-4548
FAX (719) 578-8114





NCOA

Service Center
.....
3930 Encino Dr.
Colorado Springs, CO 80918

E.L. "Ben" Benzel
Senior Master Counsellor

Bus.: (719) 599-9725
Fax: (719) 540-8387
Res.: (719) 598-6886

 AGENT FOR
ACADEMY LIFE
 A PROVIDIAN Insurance Company

WRECKMASTERS

BODY & FRAME



Jim J. Keeney
Owner

315 So. 14th St.
Colorado Springs, CO 80904
(14th & Cimarron, H-Way 24)

Bus. 520-1184
Res. 634-7378

Quality Collision Repair & Painting

THE DRIPLINE
Pikes Peak Corvair Club
PO Box 15034
Colorado Springs, Co.
80935

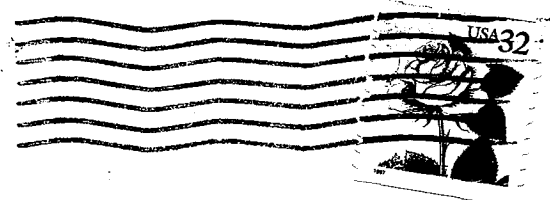

SEND TO:

Walter Hundertmark
15 El Paso Blvd #26
Manitou Spgs, Co 80829

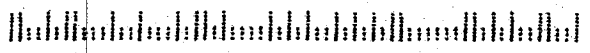

THE

DRIP LINE

VOL. 21

NO. 7 MAY 1998

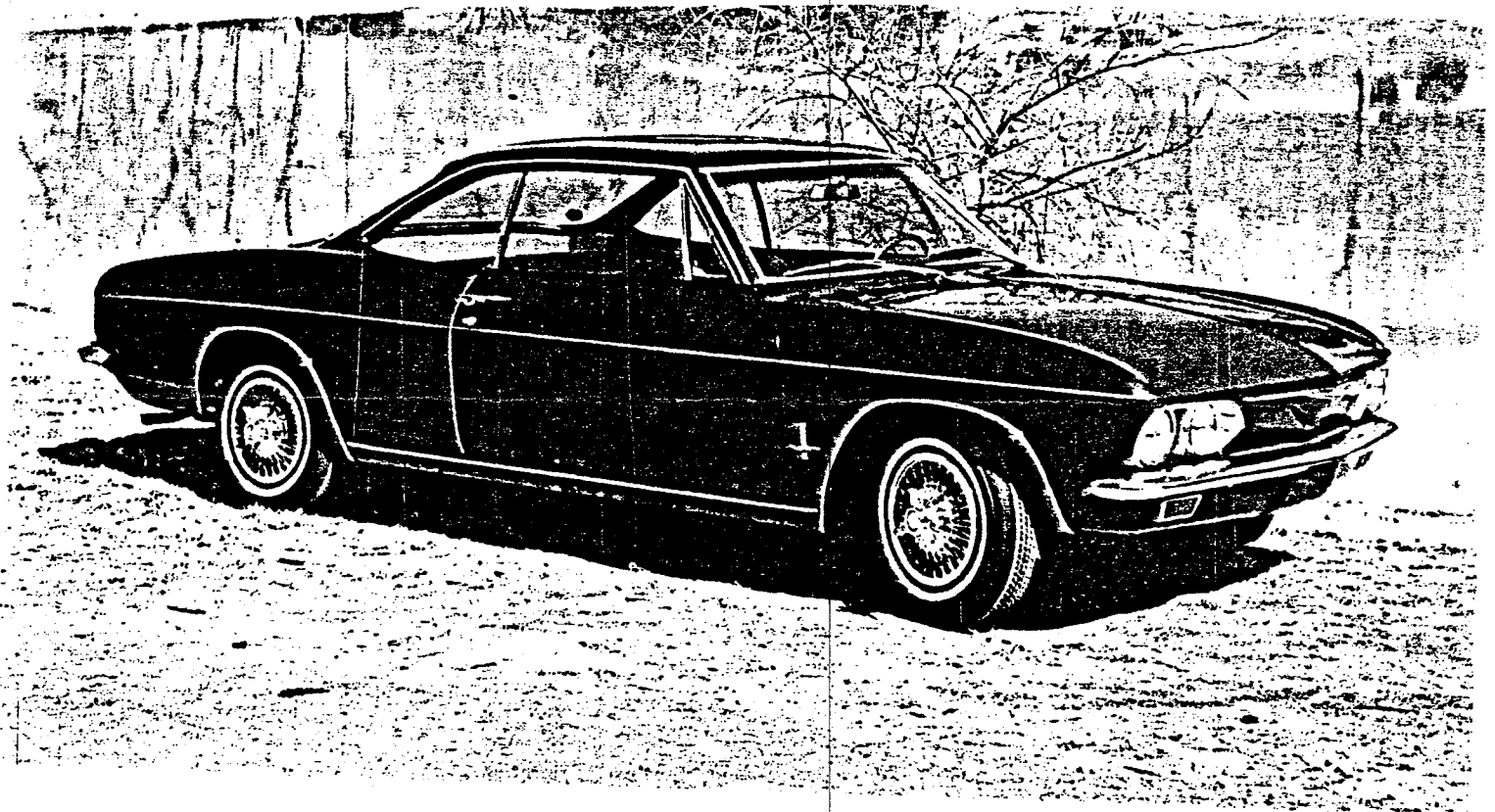

DO YOU KNOW WHAT MAY 14 MEANS ?? LOOK INSIDE FOR DETAILS!!

A Publication of:



**THE NEXT MEETING OF PPCC
IS MAY 27, 1998
AT THE NCOA CLUBHOUSE**

TIME: 7:30 pm

A Chapter of:



PIKES PEAK CORVAIR CLUB
OFFICERS 1998

PRESIDENT
VICE PRESIDENT
SECRETARY
TREASURER
DRIP LINE EDITOR

LARRY NEAL
GARRIE FOX
RUTH GOODMAN
JOHN KOLL
STEVE GOODMAN

570-9694
596-5051
(303) 934-5027
593-1928
(303) 934-5027
e-mail rearengine.steve@worldnet.att.net
598-6886

MEMBERSHIP

All correspondence To PIKES PEAK CORVAIR CLUB or it's officers should be mailed to PO Box 15034, Colorado Springs, Colo. 80935.

The DRIPLINE is a monthly publication of the PIKES PEAK CORVAIR CLUB, a non-profit organization. Deadline for submitting information to the DRIPLINE is the first Tuesday of each month for that month's publication.

Business card size ads, advertising business services of both members or non-members are \$2.50 per month. To save time and money, advertisers are asked to send \$15.00 for six (6) months or \$30.00 for one year of advertising. Send your advertising check to PIKES PEAK CORVAIR CLUB, INC. PO BOX 15034, COLORADO SPRINGS, COLO. 80935.

Simple classified advertising of CARS FOR SALE or PARTS FOR SALE or WANTED are free to members, non-members will be charged \$2.50 per issue.

NOTES FROM OUR PRESIDENT

Well, here we are in May. By the time you see this, we'll have already been at TOUR TEJON. I am sure it was an excellent event and I hope you made time to come down and see us!

The **Lake City TRI-STATE** meet is fast approaching. If you haven't gotten your reservations in yet, I have heard that the 3 host motels are full, so you will have to stay at one of the other places in town. There does seem to be a lot of B&Bs plus other lodges in the area. Call me if you need some numbers.

I imagine we'll have some sort of a car pool going down to Lake City on Friday, June 5th, we'll discuss the logistics at the monthly meeting.

Remember that we'll be having our 2nd Sunday brunch at **BARRONS** on S. Academy and Airport. Let me know if you want to attend.

A big thanks to Ruth Goodman for the excellent cake and for taking our minutes. Also thanks to Ben Benzel for letting us use his clubhouse, John Koll for keeping our books and Steve Goodman for editing our news letter and Garrie Fox for being VP. And **THANKS** to all the members who make it to the monthly meetings for info and general chat.

See you at the clubhouse!
LARRY

A TOUCH of CLASS

Professional Detailing

229 N. Cascade, Colorado Springs, CO. 80903

Fine Detailing
At It's Best



*We also specialized in
Classic, Antique &
Street Rod Detailing.*

For Appointment call
(719) 448-9313

Michael Wiltrout.

Advanced Friction Technologies, Inc.

Manufacturer & Distributor
RK-44 Oil Additive Products



J.B ISAAC
President/C.E.O

3333 C. North El Paso St.
Colorado Springs, CO 80907



(719) 578-5588
Fax (719) 578-9952
(800) TRY-RK44
<http://www.rk44.com>

THE IMPORTANCE OF MAY 14

May 14, 1969 is the date in question. It is the day that the very last CORVAIR, #6000 rolled off the assembly line and the CORVAIR lineage faded into the history books and into the hearts of CORVAIR diehards everywhere.

GM's wisdom for creating and then killing great automobiles has continued. They created the VEGA, another car for the masses. There were notchbacks, fastbacks and several styles of station wagons and delivery panel wagons. GM offered automatic trans, 3 speed and 4 speed and eventually 5 speed transmissions. In 1975 the COSWORTH VEGA appeared. The twin cam engine was a work of art and an engineering masterpiece. It also solved the weak spot of the VEGA line, the poor reliability of the aluminum cylinder walled engine. Now, what does GM do, they stop the production of the VEGA after 1977, take away that jewel of a powerplant and call it a MONZA again.

Next is the x-cars. GM creates a line of front engine cars, almost before their time (sound familiar to CORVAIR owners). After fooling around with 4 cylinder models with automatic transmissions that took all day to cross the street they finally get the X-11 on the road. This is wide wheels, HO v-6 and some graphics, does fairly good on autocross circuits and guess what, GM stops it. In many ways, the CITATION was the CORVAIR of the 80's. GM has always been on the leading edge of trying something new and/or innovative; they just never seem to follow through to the end.

Last example is the FIERO. I realize this is PONTIAC but GM is still GM. GM creates another commuter car, 4 cylinder in the beginning then v-6. Sound familiar, yes they used the x-car running gear. Moving it straight through the car they created a mid-engine 2 seater. Now wait a minute, a mid-engine 2 seater is normally called a sports car (914 PORSCHE, X-19 FIAT, MR 2 MAZDA) but GM says it is an intown pedal car. Buyers are wanting more engine and gears, GM finally gets Germany to build a 5 speed for it and after years of screwing around with the x-car suspension, GM designs a new suspension for 1988, offers v-6 and 5 speed and then stops production at the end of that year.

Each of the clubs that honor the above mentioned cars have their own May 14 also. Luckily GM continues to build cars and be pretty successful in spite of themselves.

(please note that any opinions in the above article are those of your editor)

PPCC MEMBERS WIN AT TOUR TEJON

PPCC members Jim Richards, Garrie Fox, Ken Brown, Ben Benzel, Steve and Ruth Goodman, Larry Neal and Laura and Joan Wilshire all showed their cars at the annual TOUR TEJON auto show on May 17.

There were the normal amounts of CAMARO, MUSTANG and CORVETTES present and most every car was a nice appearing automobile. It did seem that the car count was down from past years but certainly the folks visiting and looking at all the iron were plentiful. Luckily the weather was pretty cooperative too.

At the end of the day, Laura won 2nd in an open class with her 64 SPYDER convertible and Ben won 3rd in a closed class. Considering the amount of competition both should be congratulated on their efforts.

Ben also lined up two new advertisers for the **DRIPLINE** *(thank you Ben, ed)*.

Also PPCC members Judy Brown, Rose Rosemeyer, Richard Kennedy and Ron and Jenny Lezon were among the viewing public. Thanks to those who attended and those who got up very early in the morning to get into line.

MINUTES

The April meeting of PPCC was called to order by President Larry Neal at 7:33pm. 11 members were in attendance. John Koll reported \$912.00 in the treasury. It was noted that \$25.00 was sent to the DIABETES FOUNDATION in the name of Dorothy Malew. OLD BUSINESS was the discussion of Lake City and TOUR TEJON. It was agreed to meet at DENNY's at 6:00am to line up for staging on May 17. The upcoming Abby Car Show and the possibility of a drive to Cripple Creek for dinner before or after Buena Vista was discussed under new business. Also upcoming events such as the swap meet in Boulder in August and the show at Buckley ANG on June 14 were noted. The meeting was adjourned and door prize drawing were held. Winners included Jeannie Koll, Steve Goodman, Mark King, Richard King, Doug Higgins and John Koll. Dessert followed (*thank you Ruth, ed*).

Respectfully submitted, Ruth Goodman Secretary

MEMBERSHIP AND DUES

The following named PPCC members have dues **NOW DUE** or are **PAST DUE!!** If your name appears below it is time to get your check mailed to PPCC if you can't attend the gathering on MAY 27. Mail to PPCC, PO Box 15034 C/Springs, Co. 80935. Our dues are \$15.00/year and we need and appreciate your support. Questions call Ben Benzel @ 598-6886.

Del Delany	5/98	Donald Mitchell	6/98
Gene Krueger	5/98	Robert Pride	6/98
Bertie McDonald	5/98	*BRENDA RAMLO	4/98
*TIMOTHY McDONALD	4/98	Jim Richards	6/98
*ED MALEW	4/98	Dean Schmidt	6/98
*FRANCINE WEBB	4/98	Warren Wilder	6/98
*JAMES WILSON	4/98		

***denotes FINAL NOTICE** and the last issue of the *DRIPLINE*. Please send that check NOW!!!

BEN BENZEL, membership chairman

Clark's Corvair Parts, Inc.

Box CC
Shelburne Falls, Ma. 01370

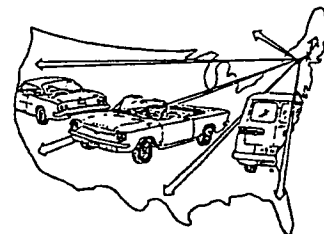

Detailed catalog, technical HELP!

24 years in business and dedicated to the Corvair's future.
friendly service

clark's - more than parts!

and NOW



Toll Free 888 *
numbers

MAIN PHONE

413-625-9776

MONDAY - FRIDAY
8:30a.m. - 5:00 p.m.
(E.S.T.)

* ORDER MACHINE

24 hour
413-625-2558

* TOLL FREE
(USA & Canada)
888-267-8247
(888-COR-VAIR)

* FAX - 24 hour
413-625-8498

* TOLL FREE
(USA & Canada)
888-625-8498

EMAIL - clarks@corvair.com
INTERNET - www.corvair.com

Clark's 3 CATALOG SET

OVER 500 pages,

OVER 3 Lbs.

OVER 14,000 part numbers

\$5.00 in USA Canada \$10.00 (foreign more)

UPCOMING EVENTS FOR 1998

MAY 27-----May general meeting of PPCC @ NCOA clubhouse starting at 7:30pm

JUNE 5-7-----**TRI-STATE** meet in Lake City

JUNE 14-----2nd Sunday brunch at **BARRONS**, Academy and Airport. Please call Larry Neal for reservations 570-9694

JUNE 24-----June general meeting of PPCC @ NCOA clubhouse

JULY 5-----**MOUNTAIN MANIA** @ Buena Vista. See entry blank in this issue of *DRIPLINE*.

JULY 28-Aug 1----National CORSA convention in St. Louis, Mo.

Kusy's

AUTO TRIM

AUTOMOTIVE AND MARINE UPHOLSTERY



BOAT TOPS & COVERS



3116 ILLINOIS
COLORADO SPRINGS, CO

633-8174

MICHAEL KUSY
OWNER

From one Corvair lover to another...

CORVAIRS

by

CREATIVE STITCHES
2710 Cancun Court
Grand Junction, CO 81506
(970) 245-4722

MEMBER of CORSA/TUCSON CORVAIR ASS'N
PIKES PEAK CORVAIR CLUB
e-mail mr-mrsvair@juno.com



HERITAGE REALTORS

S O L D O N C O L O R A D O



FINANCIAL SERVICES

Greg Bianchi
Registered Representative

Investments

- * *Mutual Funds*
- * *Annuities*
- * *IRA's*
- * *Tax Free*
- * *C.D. Alternatives*

Tax Consulting

- * *Business*
- * *Personal*

Life Insurance

- * *Term*
- * *Universal*
- * *Keyman*
- * *Buy / Sell*

Bus: 719-635-7761 WATS 800-366-7935

320 W. Fillmore, Suite 114
Colorado Springs, CO 80907-6065

All Securities Offered Through InterSecurities, Inc.
An Aegon USA Company
Member National Association of Securities Dealers, Inc.
SIPC and SEC Registered Investment Advisor

FOR SALE

Clear plastic engine deck lid for early model. This is what they used in showrooms in the 60's. This is rare and in excellent condition. Complete with hardware. \$150.00. Call Ben Benzel @ 599-9725.

WANTED TO TRADE

1965 FORD MUSTANG hardtop. Will trade straight across for 63-64 CORVAIR convertible. Discuss this with Jan in Kim, Colo. Phone (719) 643-5426

TRI-STATE UPDATE

As of this writing the 3 host motel/cabins in Lake City are understood to be full. There are a number of other motel/cabins and also bed and breakfast situations in the area. You can either call the Lake City Chamber of Commerce or try Larry Neal @ 570-9694.

Your editor stated last month that the CORVAIRS of NEW MEXICO were thinking of bringing t-shirts with them commemorating the event.

This should be a good weekend to spend in the mountains. Hopefully a lot of PPCC members will decide to attend.

JOIN CORSA ONLY \$35.00/YEAR TO KEEP OUR CARS ALIVE

WE'RE YOUR
DISCOUNT
CORVAIR PARTS
FOR THE 90'S AND BEYOND!



SERVICE
SELECTION
SATISFACTION
SIMPLE!

FOR 23 YEARS WE'VE BEEN SUPPLYING CORVAIR OWNERS WITH THE PARTS THEY NEED - ALL AT THE BEST DISCOUNT PRICES! REPRODUCED PARTS, USED PARTS, REBUILDING SERVICES - WE HAVE IT ALL! BEFORE YOU BUY MAKE SURE TO CHECK US OUT - 30 DAY NO-RESTOCKING, ONE YEAR GUARANTEE ON MOST PARTS AND SERVICES. FAST, SAME DAY SERVICE. ALL MAJOR CREDIT CARDS ACCEPTED. TOLL FREE ORDER NUMBER (1-800-825-8247). GIANT SELECTION!

ORDER OUR GIANT MAIL ORDER CATALOG - THE CORVAIR BOOK - \$5.00 NOW REFUNDABLE WITH FIRST ORDER OF \$100.00 OR MORE!

ALSO MAKE SURE YOU'RE ON OUR SUBSCRIPTION LIST FOR OUR FREE NEWSLETTER - THE CORVAIR NEWS WE NEED YOUR NAME & ADDRESS!

CORVAIR UNDERGROUND INC
PO BOX 339 DUNDEE, OR 97115
1-503-434-1648 9-5 M-F
FAX 1-503-434-1648
WWW.CORVAIRUNDERGROUND.COM



FOR SALE

Clear plastic engine deck lid for early model. This is what they used in showrooms in the 60's. This is rare and in excellent condition. Complete with hardware. \$150.00. Call Ben Benzel @ 599-9725.

WANTED TO TRADE

1965 FORD MUSTANG hardtop. Will trade straight across for 63-64 CORVAIR convertible. Discuss this with Jan in Kim, Colo. Phone (719) 643-5426

TRI-STATE UPDATE

As of this writing the 3 host motel/cabins in Lake City are understood to be full. There are a number of other motel/cabins and also bed and breakfast situations in the area. You can either call the Lake City Chamber of Commerce or try Larry Neal @ 570-9694.

Your editor stated last month that the CORVAIRS of NEW MEXICO were thinking of bringing t-shirts with them commemorating the event.

This should be a good weekend to spend in the mountains. Hopefully a lot of PPCC members will decide to attend.

JOIN CORSA ONLY \$35.00/YEAR TO KEEP OUR CARS ALIVE

WE'RE YOUR
DISCOUNT
CORVAIR PARTS
FOR THE 90'S AND BEYOND!



SERVICE
SELECTION
SATISFACTION
SIMPLE!

FOR 23 YEARS WE'VE BEEN SUPPLYING CORVAIR OWNERS WITH THE PARTS THEY NEED - ALL AT THE BEST DISCOUNT PRICES! REPRODUCED PARTS, USED PARTS, REBUILDING SERVICES - WE HAVE IT ALL! BEFORE YOU BUY MAKE SURE TO CHECK US OUT - 30 DAY NO-RE STOCKING, ONE YEAR GUARANTEE ON MOST PARTS AND SERVICES. FAST, SAME DAY SERVICE. ALL MAJOR CREDIT CARDS ACCEPTED. TOLL FREE ORDER NUMBER (1-800-825-8247). GIANT SELECTION!

ORDER OUR GIANT MAIL ORDER CATALOG - THE CORVAIR BOOK - \$5.00 NOW REFUNDABLE WITH FIRST ORDER OF \$100.00 OR MORE!

ALSO MAKE SURE YOU'RE ON OUR SUBSCRIPTION LIST FOR OUR FREE NEWSLETTER - THE CORVAIR NEWS WE NEED YOUR NAME & ADDRESS!

CORVAIR UNDERGROUND INC.
PO BOX 339 DUNDEE, OR 97115
1-503-434-1648 9-5 M-F
FAX 1-503-434-1648
WWW.CORVAIRUNDERGROUND.COM





Sunday, July 5, 1998
Main Street
Buena Vista, Colorado

OPEN TO ALL TYPES OF CARS & TRUCKS
SHOW AND SHINE ON MAIN STREET UNTIL 3:00 P.M.

AWARDS FOR TOP 5 VEHICLES PLUS SPECIAL AWARDS

Registration 8:00 A.M. to 12 NOON Entry fees: \$17.00 pre-entered, \$20.00 Gate Entry.
Includes T-Shirt and Dash Plaque (Additional cars \$5.00 - no T-shirt).

50/50 drawing

DOOR PRIZES GIVEN CONTINUOUSLY THROUGHOUT THE DAY

MAJOR PRIZES

(TO ENTRANTS ONLY AND MUST BE PRESENT TO WIN)

- ◆ **LIMITED EDITION JOHN FORCE TOOL SET**
DONATED BY: VISTA AUTO PARTS
- ◆ **SET OF BF GOODRICH TIRES** (UP TO \$500.00 VALUE).
DONATED BY: VISTA TIRE AND WHEEL AND TIRE CENTERS, INC
- ◆ **LIMITED EDITION PRINT** (Retail value of \$235.00)
DONATED BY: SNOWY MOUNTAIN FRAMING
- ◆ **\$100 GIFT CERTIFICATE**
DONATED BY: TOMKEN MACHINE

FIRST 150 ENTRANTS ELIGIBLE FOR ONE OF SEVERAL \$50.00 CASH PRIZES!
MAIL APPLICATION TO: ARKANSAS VALLEY CAR CLUB, INC.

P.O. BOX 340
BUENA VISTA, COLORADO 81211

For more information call: Paul Scott (719) 395-9373

**SATURDAY NITE - FREE BAR B CRUISE for entrants !!! FIREWORKS AT RODEO GROUNDS !!
MAYBE EVEN DRIVE-IN MOVIE (UNFORTUNATELY NOT FREE BUT LOADS OF FUN)**

OPTIMIST CLUB PANCAKE BREAKFAST DAY OF SHOW
COLUMBINE PARK - 7:00 A.M TO 9:00 A.M. ??

CUT OFF AND MAIL WITH ENTRY FEE:

PLEASE PRINT INFORMATION



NAME: _____ CAR YEAR AND MAKE: _____
ADDRESS: _____
CITY: _____ STATE : _____ ZIP: _____

BY ENTERING THIS SHOW WE ASSUME ALL LIABILITIES FOR OUR ACTIONS, AND IN THE EVENT OF AN ACCIDENT OR INJURY, WE AGREE TO HOLD HARMLESS THE ARKANSAS VALLEY CAR CLUB, INC. AND THE TOWN OF BUENA VISTA.

SIGNED: _____

PHOTO COPIES WILL BE ACCEPTED

FOR LODGING INFORMATION PLEASE CONTACT THE BUENA VISTA CHAMBER OF COMMERCE (719) 395-6612

REAR-ENGINE SPECIALISTS
 16010 W. 5th Ave. Unit 12
 Golden, Colo. 80401

Steve Goodman



(303) 278-4889 Fax (303) 936-7420



INTERSTATE BATTERY SYSTEM OF SOUTHERN COLORADO
 222 E. CUCHARRAS • COLORADO SPRINGS CO 80903

C. Max Clark
 Owner/Operator

(719) 577-4548
 FAX (719) 578-8114

NCOA

Service Center

 3930 Encino Dr.
 Colorado Springs, CO 80918

E.L. "Ben" Benzel
 Senior Master Counsellor

Bus.: (719) 599-9725
 Fax: (719) 540-8387
 Res.: (719) 598-6886



AGENT FOR
ACADEMY LIFE
 A PROVIDIAN Insurance Company

WRECKMASTERS
 BODY & FRAME



Jim J. Keeney
 Owner

315 So. 14th St.
 Colorado Springs, CO 80904
 (14th & Cimarron, H-Way 24)

Bus. 520-1184
 Res. 634-7378

Quality Collision Repair & Painting

THE DRIPLINE
 Pikes Peak Corvair Club
 PO Box 15034
 Colorado Springs, Co.
 80935

PLACE
 STAMP
 HERE

SEND TO;

PLACE ADDRESS
 LABEL HERE

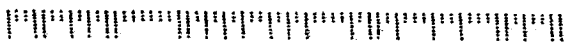

80829-2450 02

0-0

Walter Hundertmark
15 El Paso Blvd #26
Manitou Spgs, Co 80829



ISS#1 DENVER, CO 16-30 05/21/98

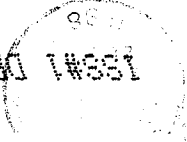

Ruth E. Goodman
4020 W. Exposition
Denver, CO 80219-2651

THE

DRIP LINE

VOL. 21

NO. 8 JUNE 1998

LARGE TURNOUT FOR TRI-STATE IN LAKE CITY

Corvairs of New Mexico hosted the annual TRI-STATE CORVAIR MEET in Lake City. 111 members and their families attended the banquet Saturday evening at the Armory, the only building in Lake City large enough to accomodate that many people.

At the start of the weekend, 39 CNM, 36 RMC, 12 PPCC and other members from California and Oklahoma as well as 2 representing BONNEVILLE in Salt Lake City lined their CORVAIRS on both sides of the street at City Park after a police escorted parade from one end of Lake City to the other. There had been a story in the Lake City newspaper about the event and the local folks literally came out of the hills to view the cars and talk with the owners.

The awards for show were as follows: Laura Wilshire (RMC/PPCC) early open with her 64 spyder convert, Daryl Jackson (RMC) early closed with 64 Monza coupe, Bob Jess of Grand Junction late open with 65 Corsa convert, Ralph McDonald (RMC) late closed with 69 Monza coupe and lastly the FC and station wagon class were lumped together, Christy Barden (RMC/ULTRA-VAN) won with his FC pickup but passed the award to Steve Gongora of CNM for his red station wagon. The distance award went to Glenn Masopust of Noble, Okla. The hard luck stories were few, John Neal (PPCC) had to replace a rear wheel bearing on his 64 Spyder convert but Chuck Vorhiss (CNM) got the award for puncturing his fuel tank with a rock on the way to the meet. Both cars were fixed fine for the drive home and no tow trucks were needed.

CNM also instituted an award in memory of Francis Boydston, long time member of CNM and also one of the founders of the TRI-STATE meet. It went to Jim Pittman who himself has been a member of CNM since the beginning and has been their newsletter editor for 20 years. Every year it will be bestowed on someone else associated with CORVAIRS and the TRI-STATE with their name engraved on the trophy. (A fitting tribute to Francis and Ruth Boydston)

The following are PPCC members attending: John/Phyllis Neal, Larry Neal, Garrie Fox, Laura Wilshire, Dale/Joan Wilshire, Bertie/Cliff McDonald, Jim/Laurel Wilson, John/Vera Hesco, Ed/Jean Olwine and Steve/Ruth Goodman.

RMC is the host for next year (1999) and Laura Wilshire, president of RMC, announced that Salida would be the host city. RMC has already made arrangements with the motels and caterers and everything sounds like it is ready to go. For the year 2000 the Bonneville club wants to host the group at Moab.

**ANOTHER VIDEO FROM MIRACLE PRODUCTIONS
OF THE TRI-STATE MEET IN LAKE CITY WILL BE
SHOWN AT THE MEETING
POPCORN OPTIONAL**

A Publication of:



The next meeting of PPCC
is JUNE 24, 1998
at the NCOA Clubhouse

Time: 7:30 pm

A Chapter of:



PIKES PEAK CORVAIR CLUB
OFFICERS 1998

PRESIDENT
VICE PRESIDENT
SECRETARY
TREASURER
DRIP LINE EDITOR

LARRY NEAL 570-9694
GARRIE FOX 596-5051
RUTH GOODMAN (303) 934-5027
JOHN KOLL 593-1928
STEVE GOODMAN (303) 934-5027
e-mail rearengine.steve@worldnet.att.net
BEN BENZEL 598-6886

MEMBERSHIP
All correspondence To PIKES PEAK CORVAIR CLUB or it's officers should be mailed to PO Box 15034, Colorado Springs, Colo. 80935.

The DRIPLINE is a monthly publication of the PIKES PEAK CORVAIR CLUB, a non-profit organization. Deadline for submitting information to the DRIPLINE is the first Tuesday of each month for that month's publication.

Business card size ads, advertising business services of both members or non-members are \$2.50 per month. To save time and money, advertisers are asked to send \$15.00 for six (6) months or \$30.00 for one year of advertising. Send your advertising check to PIKES PEAK CORVAIR CLUB, INC. PO BOX 15034, COLORADO SPRINGS, COLO. 80935.

Simple classified advertising of CARS FOR SALE or PARTS FOR SALE or WANTED are free to members, non-members will be charged \$2.50 per issue.

FROM THE PRESIDENTS E-MAIL

Hello all!

Well, last months' meeting was a little lonely. I hope a few more of you can make it out this month. We'll be showing a video of the LAKE CITY TRI-STATE meet. The New Mexico people put on an excellent show. Those of you who didn't make it should really plan on attending next years' event in Salida. **RIGHT IN OUR BACK YARD!!** This is a very fun, low key event with lots of nice people and cars, you should be there!!

Another item to note is the MOUNTAIN MANIA car show in Buena Vista on July 5th. We usually have 6 or so Corvairs in attendance and it's a nice show to just walk around and look at the cars.

A big thanks to Steve Goodman for loaning us the axle and bearing up in Lake City. I don't think the Spyder would have made it home without it.

Thanks again to Ruth Goodman who keeps providing us with the great goodies at the meetings and for taking the notes. Thanks as well to Steve G., John K., Ben B. and Garrie F.x for the things they do and just being there.

See ya'll at the meeting.

LARRY NEAL, *president*

A TOUCH of CLASS

Professional Detailing

229 N. Cascade, Colorado Springs, CO. 80903

Fine Detailing
At It's Best



*We also specialized in
Classic Antique &
Street Rod Detailing.*

Michael Wiltout

For Appointment call
(719) 448-9313

Advanced Friction Technologies, Inc.

Manufacturer & Distributor
RK-44 Oil Additive Products



J.B ISAAC
President/C.E.O

3233 C. North El Paso St.
Colorado Springs, CO 80907



(719) 578-5588
Fax (719) 578-9952
(800) TRY-RK44
<http://www.rk44.com>

MEETING MINUTES

The June meeting of PPCC was called to order by President Larry Neal at 7:37pm. There were only 8 PPCC members present. John Koll reported on the MCCA tour. Also a hobo picnic was discussed. On a slightly off note the topic went to airplanes. The upcoming Tri-state meet and the just passed Tour Tejon were also subjects of discussion.

New business included a \$6500 Monza for sale and powder coating. A discussion ensued over the pro and con of being associated with the Old Car Council. Meeting adjourned to dessert (*thank you Ruth, ed*). With the short attendance there were no door prize drawings.

Respectfully submitted, Ruth Goodman, secretary

PPCC MEMBER AT WASSON HIGH SCHOOL

PPCC member Warren Wilder and the rest of Wasson High School's shop class made history when the students involved with the program lettered in DRAG RACING. Joe Romero who was a guest at a PPCC meeting several months ago and fellow instructor Warren Wilder are involved with helping their students build, maintain and race 1966 Chevelle. Warren is also interested in starting a restoration class in the near future using a CORVAIR as the subject.

WASSON HIGH SCHOOL as well as Warren and Joe Romero were featured in the DENVER POST and also THE LATEST SCOOP. The students involved must have a 'c' or better in their classes and a 'b' or better in shop, work on the race car, have both a valid Colorado license and a drag racing license. They must also be involved for over half the races for the season.

(when the class begins the CORVAIR project hopefully some support will come from PPCC, ed.)

Clark's Corvair Parts, Inc.

Box CC
Shelburne Falls, Ma. 01370

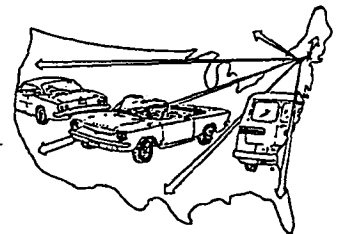

Detailed catalog, technical HELP!

24 years in business and dedicated to the Corvair's future.

friendly service

clark's - more than parts!

and NOW

NEW

Toll Free 888 * numbers

MAIN PHONE

413-625-9776

MONDAY - FRIDAY
8:30a.m. - 5:00 p.m.
(E.S.T.)

* ORDER MACHINE

24 hour
413-625-2558

* TOLL FREE

(USA & Canada)
888-267-8247
(888-COR-VAIR)

* FAX - 24 hour
413-625-8498

* TOLL FREE

(USA & Canada)
888-625-8498

EMAIL - clarks@corvair.com
INTERNET - www.corvair.com

Clark's 3 CATALOG SET

OVER 500 pages,

OVER 3 Lbs.

OVER 14,000 part numbers

\$5.00 in USA Canada \$10.00 (foreign more)

3rd Annual Customs & Classics Street Show

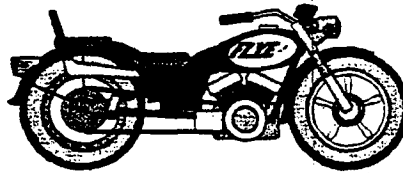
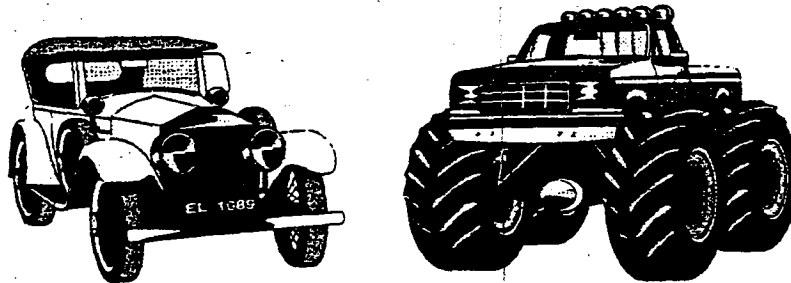

*When: August 1, 1998
12:00 noon to 4:00 p.m.*

*Where: Parking lot of T's Automotive
& Machine.*

3121 B N El Paso St.

*All Street Rods, Hot Rods, Classics, Low Riders,
Trucks, Motorcycles are invited to come*

*Vehicle entrance fee \$5.00 Admission \$1.00
Children under 12 free*

For more information contact T's Auto at 471-8171

MEMBERSHIP AND DUES

The following named PPCC members have dues **NOW DUE** or are **PAST DUE!!** If your name appears below, it is time to get your check mailed to PPCC. **OR BETTER YET**, bring your money to the meeting on June 24. Mail to PPCC, PO Box 15034, C/Springs, Colo. 80935. Dues are only \$15.00 and we need and appreciate your support. Questions, call Ben @ 598-6886.

Ken Brown	7/98	*FRANCINE WEBB	5/98
Jim Emerson	7/98	*GENE KRUEGER	5/98
Cindy Hupp	7/98	*BERTIE MC DONALD	5/98
Carl White	7/98	L Roseburrow	7/98

*denotes **FINAL NOTICE** and the last issue of the **DRIPLINE**. Send that check **NOW!!**

FOR SALE

Clear plastic engine deck lid for early model. These were used in showroom displays in the '60s. It is rare and in excellent condition, complete with hardware. \$150.00. Call Ben B. @ 598-6886

1966 MONZA 2dr hdt. 110/pg. Body straight and NO rust. Needs restoration. \$1000.00,OBO. Call Ruby Watt (719) 635-4980

ENGINES for sale--140 stick/builder only \$200.00 2ea 110 stick. Both are supposed to run but I will not promise anything except they turn over. Start it up and see if it runs or at least do a top end rebuild before using. \$200.00 ea. Call Steve @ Rear Engine (303) 278-4889

JOIN CORSA ONLY \$35.00/YEAR TO KEEP OUR CARS ALIVE

WE'RE YOUR
DISCOUNT
CORVAIR PARTS
FOR THE 90'S AND BEYOND!



SERVICE
SELECTION
SATISFACTION
SIMPLE!

FOR 23 YEARS WE'VE BEEN SUPPLYING CORVAIR OWNERS WITH THE PARTS THEY NEED - ALL AT THE BEST DISCOUNT PRICES! REPRODUCED PARTS, USED PARTS, REBUILDING SERVICES - WE HAVE IT ALL! BEFORE YOU BUY MAKE SURE TO CHECK US OUT - 30 DAY NO-RESTOCKING, ONE YEAR GUARRANTEE ON MOST PARTS AND SERVICES. FAST, SAME DAY SERVICE. ALL MAJOR CREDIT CARDS ACCEPTED. TOLL FREE ORDER NUMBER (1-800-825-8247). GIANT SELECTION!

ORDER OUR GIANT MAIL ORDER CATALOG - THE CORVAIR BOOK - \$5.00 NOW REFUNDABLE WITH FIRST ORDER OF \$100.00 OR MORE!

ALSO MAKE SURE YOU'RE ON OUR SUBSCRIPTION LIST FOR OUR FREE NEWSLETTER - THE CORVAIR NEWS WE NEED YOUR NAME & ADDRESS!

CORVAIR UNDERGROUND INC
PO BOX 339 DUNDEE, OR 97115
1-503-434-1648 9-5 M-F
FAX 1-503-434-1648
WWW.CORVAIRUNDERGROUND.COM

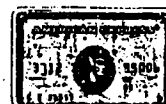

GOOD TIMES CAR SHOW

PROCEEDS FROM THIS EVENT TO BENEFIT



**CANINE COMPANIONS
FOR INDEPENDENCE**

HOSTED BY: SOUTHERN COLORADO MOPARS, PIKES PEAK CAMARO CLUB

COLORADO CRUIZERS

SHOW OPEN TO ALL MAKES ~ ALL MODELS ~ ALL YEARS

WHEN: July 25 & 26, 1998

WHERE: OLD COLORADO CITY ~ BANCROFT PARK

**SATURDAY: July 25th: Drive on up to CRUIZERS DRIVE-IN in
Woodland Park and pre-register from 5PM to 8PM**

SUNDAY: July 26th Move in 7am to 9am Show and Shine from 9am to 3pm Awards at 3pm

ENTRY FEE: \$10.00 Per Car before July 19th, \$15.00 after.
First 200 entries will receive a goodie bag and dash plaque.

**DIRECTIONS: Take I-25 to Exit 141, then west on Highway 24 to 31st Street, then north on
31st Street to West Colorado Avenue, then east on West Colorado Avenue to barricades.**

T-Shirts will be for sale at Show site

DOOR PRIZES ~ REFRESHMENTS ~ FUN FOR ALL

for more information call Dave Alexander (719) 597-9002, Mike DeMonico (719-390-8902)
or Neil Quatkemeyer (719-392-3715)

REGISTRATION

NAME _____

ADDRESS _____

PHONE _____

YEAR _____ MAKE _____

MODEL _____

CLUB AFFILIATION _____

INSURANCE CO. _____

MAKE CHECKS PAYABLE TO:

GOOD TIMES CAR SHOW.

LIABILITY WAIVER:

*Applicant agrees to hold harmless
the Good Times Car Show, Old Colorado
City & Merchants, all Host Clubs, its
members and any volunteers from and
against any claim which might or does
arise out of participation in this event.*

SIGNATURE: _____

**(Must have Signature of Parent or
Guardian if under 18)**

**SEND ENTRY & CHECK TO:
GOOD TIMES CAR SHOW
P.O. BOX 15254
COLORADO SPRINGS, CO 80935-5754**

UPCOMING EVENTS FOR 1998

- JUNE 24-----June general meeting of PPCC @ NCOA Clubhouse
Time: 7:30pm Bring a guest
- JULY 5-----MOUNTAIN MANIA @ Buena Vista
- JULY 12-----2nd Sunday Brunch at BARONS, Academy and Airport.
Please call Larry Neal for reservations 570-9694
- JULY 22-----July general meeting of PPCC
- JULY 25-26-----GOOD TIMES CAR SHOW @ Old Colorado City
See entry blank in this issue of the DRIPLINE
- JULY 28-AUG 1-----National CORSA convention in St. Louis, Mo
- AUG 1-----3rd Annual Customs & Classics Street Show.
See entry blank in this issue of the DRIPLINE

Kusy's

AUTO TRIM

AUTOMOTIVE AND MARINE UPHOLSTERY



BOAT TOPS & COVERS



MICHAEL KUSY
OWNER

3116 ILLINOIS
COLORADO SPRINGS, CO

633-8174

From one Corvair lover to another...

CORVAIRS

by

CREATIVE STITCHES
2710 Cancun Court
Grand Junction, CO 81506
(970) 245-4722

MEMBER of CORSA/TUCSON CORVAIR ASS'N
PIKES PEAK CORVAIR CLUB
e-mail mr-mrsvair@juno.com



GARRIE L. FOX
M.A. RESOURCE MGMT.
BROKER ASSOCIATE
5265 N. Academy Blvd., #3300
Colorado Springs, CO 80918
Office: (719) 548-0400
Fax: (719) 548-9475
Home: (719) 596-5051

HERITAGE
REALTORS

S O L D O N C O L O R A D O



FINANCIAL SERVICES

Greg Bianchi
Registered Representative

Investments

- * *Mutual Funds*
- * *Annuities*
- * *IRA's*
- * *Tax Free*
- * *C.D. Alternatives*

Tax Consulting

- * *Business*
- * *Personal*

Life Insurance

- * *Term*
- * *Universal*
- * *Keyman*
- * *Buy / Sell*

Bus: 719-635-7761 WATS 800-366-7935

320 W. Fillmore, Suite 114
Colorado Springs, CO 80907-6065

All Securities Offered Through InterSecurities, Inc.
An Aegon USA Company
Member National Association of Securities Dealers, Inc.
SIPC and SEC Registered Investment Advisor



REAR-ENGINE SPECIALISTS
 16010 W. 5th Ave. Unit 12
 Golden, Colo. 80401

Steve Goodman

(303) 278-4889 Fax (303) 936-7420

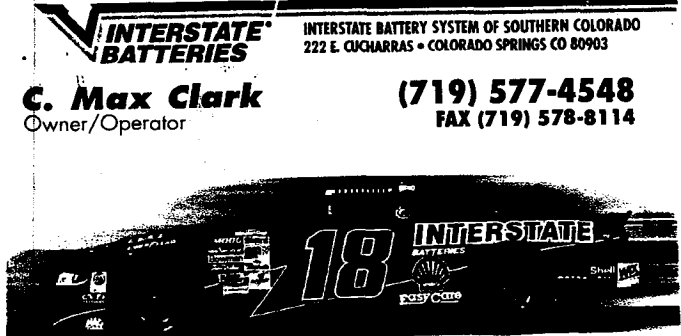

INTERSTATE BATTERIES
 INTERSTATE BATTERY SYSTEM OF SOUTHERN COLORADO
 222 E. CUCHARRAS • COLORADO SPRINGS CO 80903

C. Max Clark
 Owner/Operator

(719) 577-4548
 FAX (719) 578-8114



Service Center

 3930 Encino Dr.
 Colorado Springs, CO 80918

E.L. "Ben" Benzel
 Senior Master Counsellor

Bus: (719) 599-9725
 Fax: (719) 540-8387
 Res: (719) 598-6886



AGENT FOR
ACADEMY LIFE
 A PROVIDIAN Insurance Company



WRECKMASTERS
 BODY & FRAME

Jim J. Keeney
 Owner

315 So. 14th St.
 Colorado Springs, CO 80904
 (14th & Cimarron. H-Way 24)

Bus. 520-1184
 Res. 634-7378

Quality Collision Repair & Painting

THE DRIPLINE
 Pikes Peak Corvair Club
 PO Box 15034
 Colorado Springs, Co.
 80935

DCR #9 DENVER, CO. 21:00 06/19/98



SEND TO:

Walter Hundertmark
 15 El Paso Blvd #26
 Manitou Spgs, Co 80829



THE

DRIP LINE

VOL. 21

NO. 9 JULY 1998

MOUNTAIN MANIA IN BUENA VISTA

About 170 rods, restored and sports cars invaded Buena Vista for the annual MOUNTAIN MANIA street show on July 5. PPCC was represented by: Larry Neal (65 140 convert), Doug Higgins (65 turbo coupe), Garrie Fox (65 turbo convert), Brad Weaver and daughters (66 FI 4dr sedan), Steve/Ruth Goodman (62 turbo coupe) and Mike Britton (64 110 convert). John and Phyllis Neal started out for Buena Vista but were forced to turn back due to a faulty generator on John's 64 spyder convert. Luckily they were near home so were not stranded along the road. Virtually all attendees won a door prize of some sort. PPCC was even on the shady side of the street this year.

The usual tough drive back to town was lessened this year by hanging around a restaurant for a long time. After leaving Buena Vista at about 6:00pm, the drive back was not too bad. On a side and sad note, Delaney's Depot, a very good restaurant in Buena Vista is closed due to the owners death. Delaney's was always a good stopping spot on any drive.

Next year MOUNTAIN MANIA will be held on July 11 due to July 4th being on Sunday. This should really relax the driving time and also should get some of the PPCC members who use the 4th weekend for other things free to attend.

AUGUST PICNIC MEETING

PPCC members should be sure and note **AUGUST 26**. This will be the **annual picnic meeting**. Hopefully members who cannot attend normally through the year will be able to come to this afternoon and evening affair. There will be a **\$2.00** per head charge to offset the expenses, this will get you hamburgers and/or brauts and drinks. All utensils will be furnished. Just bring a side dish, either salad, veggie or dessert.

The eating will begin about **6:30** in order to give time to those getting off late from work or who have a long drive to get the meeting.

Please make an effort to attend. The attendance has been short this entire year and those of us who attend the meetings would like to see some more you and this meeting is the best time to just sit around and visit and also look at the CORVAIRS that all of us have driven.

THERE WILL BE A VIDEO OF BUENA VISTA AT THE JULY MEETING.

A Publication of:

(brought to you by MIRACLE PRODUCTIONS)

A Chapter of:



The next meeting of PPCC
is July 22, 1998
at the NCOA Clubhouse

Time: 7:30 pm



PIKES PEAK CORVAIR CLUB
OFFICERS 1998

PRESIDENT
VICE PRESIDENT
SECRETARY
TREASURER
DRIP LINE EDITOR

LARRY NEAL 570-9694
GARRIE FOX 596-5051
RUTH GOODMAN (303) 934-5027
JOHN KOLL 593-1928
STEVE GOODMAN (303) 934-5027
e-mail rearengine.steve@worldnet.att.net

MEMBERSHIP BEN BENZEL 598-6886

All correspondence To PIKES PEAK CORVAIR CLUB or it's officers should be mailed to PO Box 15034, Colorado Springs, Colo. 80935.

The DRIPLINE is a monthly publication of the PIKES PEAK CORVAIR CLUB, a non-profit organization. Deadline for submitting information to the DRIPLINE is the first Tuesday of each month for that month's publication.

Business card size ads, advertising business services of both members or non-members are \$2.50 per month. To save time and money, advertisers are asked to send \$15.00 for six (6) months or \$30.00 for one year of advertising. Send your advertising check to PIKES PEAK CORVAIR CLUB, INC. PO BOX 15034, COLORADO SPRINGS, COLO. 80935.

Simple classified advertising of CARS FOR SALE or PARTS FOR SALE or WANTED are free to members, non-members will be charged \$2.50 per issue.

NOTES FROM THE PRESIDENT

GREETINGS EVERYONE!

Everyone really enjoyed the video from Lake City. Steve Goodman did a great job capturing the event.

The Buena Vista car show was enjoyable as always. We had 6 cars; Steve and Ruth Goodman's 62 turbo coupe, Garrie Fox had two cars, his blue 66 FI sedan driven by Brad Weaver and daughters and his 65 turbo convert, Doug Higgins brought his 65 turbo coupe, Mike Britton (who doesn't belong to any club) had his 64 monza convert and my 65 140 convert. Honorable mention goes out to John and Phyllis Neal who tried to drive their 64 spyder but had fan belt and generator problems leaving Colorado Springs. Steve's 'MIRACLE PRODUCTIONS will be providing a video of the event at our July meeting (SEE YOU THERE) This was a pretty good showing of our CORVAIRS, thanks everyone!

Remember that next month (August) is picnic month. The club provides the meat (hamburgers, brauts) drinks and utensiles for \$2.00 a head. This is always one of our biggest events so I expect to see everyone there.

Rocky Mountain Corsa is also having their picnic/swap meet at Christy Bardens' home this year on August 9th. Same setup as ours. A nice way to mingle with other CORVAIR enthusiasts.

Thanks again to everyone who helps run the club and to Ruth Goodman who always brings the most delicious treats for the meeting.

Well, that is about it, we'll see you at the meeting.

Larry Neal

A TOUCH of CLASS

Professional Detailing

229 N. Cascade, Colorado Springs, CO. 80903

Fine Detailing
At It's Best



*We also specialized in
Classic Antique &
Street Rod Detailing.*

For Appointment call
(719) 448-9313

Michael Wiltrout

Advanced Friction Technologies, Inc.

Manufacturer & Distributor
RK-44 Oil Additive Products



J.B ISAAC
President/C.E.O



3333 C. North El Paso St.
Colorado Springs, CO 80907

(719) 578-5588
Fax (719) 578-9952
(800) TRY-RK44
<http://www.rk44.com>

MEETING MINUTES

The July meeting of PPCC was called to order by VP Garrie Fox at 7:38pm. There were 13 members present, no guests. Treasurer John Koll reported over \$800 in the treasury. OLD BUSINESS: Lake City was discussed also the truck show that Walt Hundertmark and John Koll attended. NEW BUSINESS: RMC is hosting a cruise at Ritzy's on June 22. It was also announced that Salida, Co would be the site of next year's Tri-state Corvair meet, hosted by RMC. Upcoming events such as Mountain Mania and the picnic in Denver as well as the one at the August 26th PPCC meeting were discussed too. MEMBERSHIP: Ben Benzel reported the loss of two members due to non-payment of dues. The request was made to have catalogs from Clarks and Walls. Walls is on order now. Several ads were read followed by the video and door prizes. *(Thank you Ruth for the dessert, ed).*

Respectfully submitted, Ruth Goodman, secretary

FUEL INJECTION FOR YOUR CORVAIR

In the San Diego Corvair Club's newsletter called **VAIRMAIL** there is an article about fuel injection added to the CORVAIR engine. Now most of us know about Garrie Fox's FI cars that Milt Binon built a few years ago. Milt used DATSUN 280ZX for his conversions and the 3 cars that Garrie own are all fine running automobiles. If there is a disadvantage to the DATSUN system it is the fact that the heads are extensively modified for the injectors as well as other modifications needed for mounting the sensors.

The article in VAIRMAIL uses a GM throttle body injection unit (TBI) sitting on a center mount 4 bbl manifold with runners to the 140 intake ports. It states that a business in Calif called 'TURBO CITY' sells this kit as a universal part. It sells for \$1,195.00. If it is the same unit that GM installed on their engines from about 1987 til the time they (GM) changed to the TPI (tuned port injection), there should be some in the wrecking yards. The typical v-6 GM engine was a little more displacement than the 164 ci CORVAIR but with some adjusting it should work just fine and maybe less expensive than the unit from TURBO CITY. If you are interested in the universal installation, call (714) 639-4933. I might add that a high pressure fuel pump is needed also for an additional \$135.00. Once again, that pump may be on the GM car in the bone yard although it may be an 'in the tank' unit which might be difficult to adapt.

I would suggest reading all the tech info on the fuel injection unit before raiding the wrecking yards. There are more parts that what are attached to the intake manifold that make the unit work.

(The above is a combination of VAIRMAIL text and comments by your editor. Thanks to the San Diego Corvair Club for exchanging newsletters.)

FOR SALE --PARTS--

Clear plastic engine deck lid for early model. It is rare and in excellent condition. Complete with hardware. \$150.00. Call Ben B @ 598-6886

FOR SALE --CARS--

1962 CORVAIR SPYDER coupe. 150/4 Engine runs great (rebuilt in 83) and has been driven 2500 miles in past 15 years. Price \$1800.00 firm. Call Jim DeBolt @ (719) 481-2663 (pd ad)

1963 CORVAIR SPYDER convert. Car located in Saratoga, Wyo. Brown out/ tan in. Runs Older restoration, odometer broken, reads 48,000 miles was repossessed and repo title available. Offers accepted by sealed bid and reserve right to refuse bid. Call Dan for more info. Day (307) 326-8314 or evening (307) 326-5302 (pd ad)

1964 CORVAIR MONZA coupe. Excellent condition, runs and looks great. High output alternator, heater, air conditioned, new exhaust system, new stereo, new interior, new tires, many receipts. White w/blue stripes. Asking \$6500.00 Zachery Smith @ (719) 589-5333 (pd ad)

UPCOMING EVENTS FOR 1998

- JULY 22-----July general meeting of PPCC. Time 7:30pm @ the NCOA clubhouse. Please attend and bring a guest
- JULY 28-AUG 1-----National CORSA convention in St. Louis, Mo
- AUG 1-----3rd Annual Customs and Classics street show, entry blank in last months DRIPLINE
- AUG 9-----Annual picnic/swap meet sponsored by RMC (Denver) at Christy Barden's in Boulder. Map in this issue of the DRIPLINE. All PPCC members are invited.
- AUG 26-----**AUGUST PICNIC** meeting of PPCC at the clubhouse. Beginning around 6:30pm. PLEASE ATTEND--see story this issue of the DRIPLINE

Kusy's

MICHAEL KUSY
OWNER

AUTO TRIM

AUTOMOTIVE AND MARINE UPHOLSTERY

BOAT TOPS & COVERS

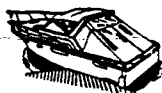

3116 ILLINOIS
COLORADO SPRINGS, CO

633-8174

From one Corvair lover to another...

CORVAIRS

by

CREATIVE STITCHES
2710 Cancun Court
Grand Junction, CO 81506
(970) 245-4722

MEMBER of CORSA/TUCSON CORVAIR ASS'N
PIKES PEAK CORVAIR CLUB
e-mail mr-mrsvair@juno.com

GARRIE L. FOX
M.A. RESOURCE MGMT.
BROKER ASSOCIATE
5265 N. Academy Blvd., #3300
Colorado Springs, CO 80918
Office: (719) 548-0400
Fax: (719) 548-9475
Home: (719) 596-5051



HERITAGE
REALTORS

S O L D O N C O L O R A D O



FINANCIAL SERVICES

Greg Bianchi
Registered Representative

Investments

- * *Mutual Funds*
- * *Annuities*
- * *IRA's*
- * *Tax Free*
- * *C.D. Alternatives*

Tax Consulting

- * *Business*
- * *Personal*

Life Insurance

- * *Term*
- * *Universal*
- * *Keyman*
- * *Buy / Sell*

Bus: 719-635-7761 WATS 800-366-7935

320 W. Fillmore, Suite 114
Colorado Springs, CO 80907-6065

All Securities Offered Through InterSecurities, Inc.
An Aegon USA Company
Member National Association of Securities Dealers, Inc.
SIPC and SEC Registered Investment Advisor

rocky mountain corsa

Ninth Annual Front Range CORVAIR BBQ and Swap Meet

SUNDAY AUGUST 9 1998

Bring all your old or new Corvaair parts to swap or sell. B-B-Q'd Hamburgers and hot dogs with all the trimmings, along with, soda pop and coffee. FREE VIDEO'S, Bring yours!

Please bring chips, dips, salads or deserts and side dishes to share. (Also bring plates, cups and eating utensils for yourself). Bring tables or ground tarps to display your parts or other items for sale. Portable chairs and sun protection would be in order. Rain or shine we start at 11:00 a.m. Fan belt toss, and Trans. demo.

The event will be held at the home of **CHRISTY BARDEN** 5537 Pioneer Road, Boulder. (303) 530-1288 (see map). For Information please call Bob Attwood at 699-8894

The easiest way to find Christy's is go through town on Highway 36 also called 28th Street and turn east on the Diagonal Highway (Hy 119). When you turn south on 55th street you cross the R.R. tracks. Christy's back yard is next to these R.R. tracks.

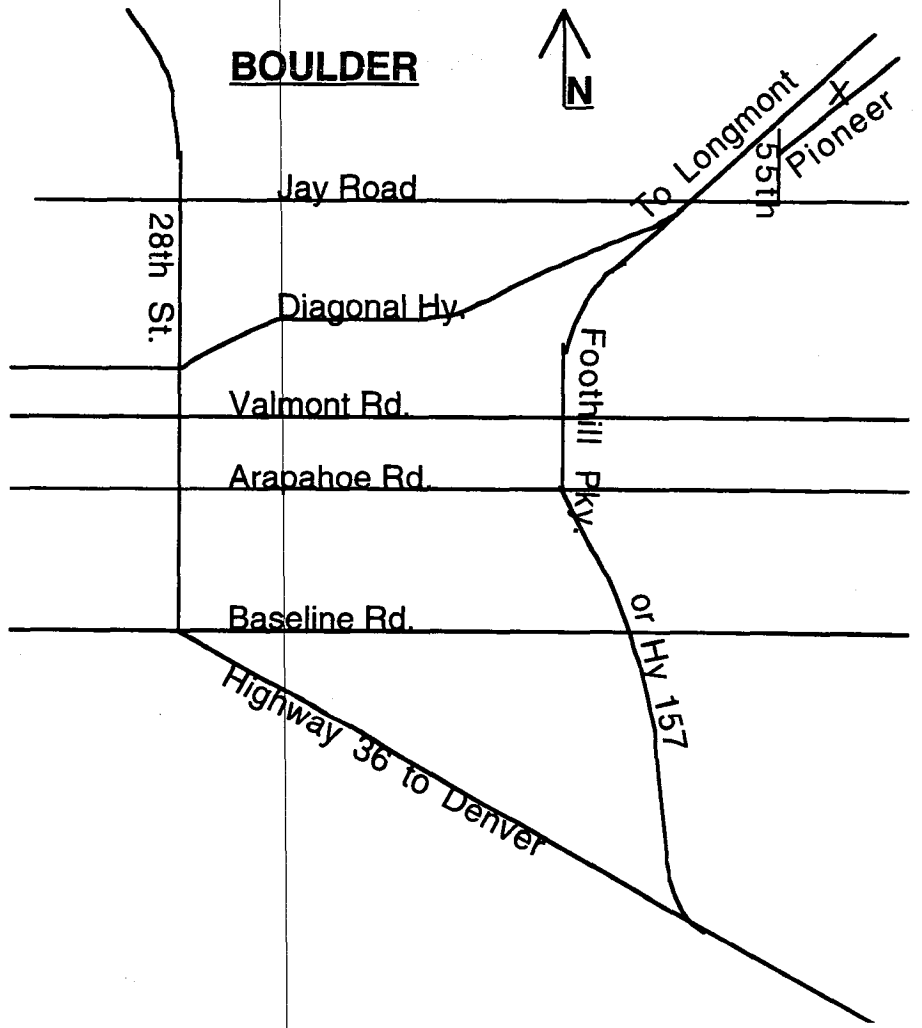

MEMBERSHIP AND DUES

The following named PPCC members have dues **NOW DUE** or are **PAST DUE!!** If your name appears below, it is time to get your check to us. Better yet, bring it to the meeting on July 22. Mail to PPCC, PO BOX 15034 C/Springs, Co 80935. Dues are only \$15.00 per year and we need and appreciate your support. Questions call Ben @ 598-6886.

Jim Emerson	7/98	L Roseburrow	7/98
Marshall Hesler	8/98	John Smith	8/98
Doug Higgins	8/98	Carl White	7/98
Sidney Jones	8/98	Jerry Murphy	8/98

We have 54 members in our fine club. For those of you who are not CORSA members I encourage your membership. See application elsewhere in the *DRIPLINE*.

Ben Benzel, membership chairman

NEW MEMBERS WELCOME

Kenneth and Darcie Maurer are the proud owners of a 62 Grenbrier which has been in the family since 64 and a 67 coupe which was his first car. They reside at 929 High Road, Manitou Springs, Co 80829. A warm welcome to PIKES PEAK CORVAIR CLUB.

Ben Benzel, membership chairman

JOIN CORSA ONLY \$35.00/YEAR TO KEEP OUR CARS ALIVE

WE'RE YOUR
DISCOUNT
CORVAIR PARTS

FOR THE 90'S AND BEYOND!



SERVICE
SELECTION
SATISFACTION
SIMPLE!

FOR 23 YEARS WE'VE BEEN SUPPLYING CORVAIR OWNERS WITH THE PARTS THEY NEED - ALL AT THE BEST DISCOUNT PRICES! REPRODUCED PARTS, USED PARTS, REBUILDING SERVICES - WE HAVE IT ALL! BEFORE YOU BUY MAKE SURE TO CHECK US OUT - 30 DAY NO-RESTOCKING, ONE YEAR GUARRANTEE ON MOST PARTS AND SERVICES. FAST, SAME DAY SERVICE. ALL MAJOR CREDIT CARDS ACCEPTED. TOLL FREE ORDER NUMBER (1-800-825-8247). GIANT SELECTION!

ORDER OUR GIANT MAIL ORDER CATALOG - THE CORVAIR BOOK - \$5.00 NOW REFUNDABLE WITH FIRST ORDER OF \$100.00 OR MORE!

ALSO MAKE SURE YOU'RE ON OUR SUBSCRIPTION LIST FOR OUR FREE NEWSLETTER - THE CORVAIR NEWS WE NEED YOUR NAME & ADDRESS!

CORVAIR UNDERGROUND INC
PO BOX 339 DUNDEE, OR 97115
1-503-434-1648 9-5 M-F
FAX 1-503-434-1648
WWW.CORVAIRUNDERGROUND.COM





Corvair Society of America

Founded by and for those who still appreciate the Corvair Automobile
P.O. Box 607, Lemont, IL 60439-0607 • 630/257-6530 • fax 257-5540

Membership Application

First Name _____ Last Name _____

Street Address _____

City _____ State/Prov. _____ Zip Code _____ Country _____

Telephone Number (_____) _____ Occupation _____

Fee Schedule

- 1 year membership \$35
- 26 month membership 70
- *1 year Canadian membership 38
- *26 month Canadian membership 76
- *1 year overseas membership 48
- *26 month overseas membership 96
- _____ Corvair Preservation Foundation Donation . min. \$1
- _____ Racing Fund Donation min \$1

Corvair Preservation Foundation



The Corvair Preservation Foundation is established to protect and preserve Corvair memorabilia.

Racing Fund

This fund provides cash prizes to winning Corvairs entered in national open class racing.

*Must be paid in funds drawn on U.S. banks.

to pay by credit card

Circle One   	Card No. _____	Expiration Date _____
Signature _____	Amount _____	

Please make check or money order payable to CORSA, Inc. and mail to: CORSA, Inc., P.O. Box 607, Lemont, IL 60439-0607. Membership includes subscription to the CORSA *Communique*, however there may be a four to six week delay before you receive your first magazine.

CORSA's Board of Directors welcomes you to the Corvair Society of America. To help us better understand your needs and desires, and to aid in charting the direction of future CORSA growth, we request that you take a few moments to answer the following questions.

- How did you hear about CORSA? _____
- What is your primary interest in Corvairs? (Transportation, restoration, etc.) _____
- How many Corvairs do you have? _____ Running _____ Restorable _____ Parts cars _____
- Are you a long time owner? _____ First time owner? _____ Previous owner who has reacquired a Corvair? _____
- Approximately how many Corvair-miles do you drive in a year? _____
- Do you do your own mechanical work? _____ Body work? Major _____ Minor _____
- What other cars do you own or use for daily transportation? _____
- What do you hope to gain from membership in CORSA? (Technical information, parts availability, competition information, social information, etc.) _____

CORSA currently has over 130 chapters throughout the world. We encourage membership in our local chapters; if you do not wish to be contacted by a local chapter check the box below. If you already belong to a CORSA chapter, please indicate the chapter number so that we can add it to our records.

Please do not contact a CORSA chapter on my behalf. I belong to CORSA chapter # _____.

Sponsor _____ CORSA ID # _____



REAR-ENGINE SPECIALISTS
 16010 W. 5th Ave. Unit 12
 Golden, Colo. 80401

Steve Goodman

(303) 278-4889 Fax (303) 936-7420

INTERSTATE BATTERIES
 INTERSTATE BATTERY SYSTEM OF SOUTHERN COLORADO
 222 E. CUCHARRAS • COLORADO SPRINGS CO 80903

C. Max Clark
 Owner/Operator

(719) 577-4548
 FAX (719) 578-8114

NCOA

Service Center

 3930 Encino Dr.
 Colorado Springs, CO 80918

E.L. "Ben" Benzel
 Senior Master Counsellor

Bus.: (719) 599-9725
 Fax: (719) 540-8387
 Res.: (719) 598-6886



AGENT FOR
ACADEMY LIFE
 A PROVIDIAN Insurance Company

WRECKMASTERS
 BODY & FRAME

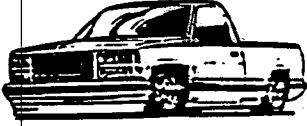

Jim J. Keeney
 Owner

315 So. 14th St.
 Colorado Springs, CO 80904
 (14th & Cimarron, H-Way 24)

Bus. 520-1184
 Res. 634-7378

Quality Collision Repair & Painting

THE DRIPLINE
 Pikes Peak Corvair Club
 PO Box 15034
 Colorado Springs, Co.
 80935

DDR #9 DENVER, CO. 00:32 98

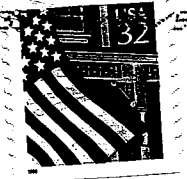

SEND TO:

Walter Hundertmark
 15 El Paso Blvd #26
 Manitou Spgs, Co 80829

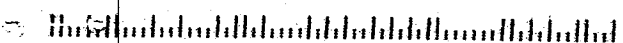

THE

DRIP LINE

**VOL. 21
NO. 10 AUGUST 1998**

PICNIC MEETING

AUGUST 26 6:30pm

BRING YOUR FAVORITE SALAD OR DESSERT

DRIVE A CORVAIR AND BRING YOUR APPETITE

PICNIC/SWAP MEET IN DENVER

The annual picnic and swap meet sponsored by RMC was held at Christy Barden's home in Boulder on August 9. Attending from PPCC were John and Phyllis Neal, Larry Neal, Garrie Fox, Doug Higgins, Ben and Vesta Fulcher, Ben Benzel, Marsh and Carole Hesler as well as PPCC/RMC combined members Laura Wilshire, Dale and Joan Wilshire, Ed and Jean Olwine and Steve and Ruth Goodman.

Christy's back yard had plenty of room for CORVAIR parking and spreading parts out on the ground. It also offered plenty of shade for sitting around and visiting plus eating. The weather cooperated pretty well also, only a very light sprinkle that passed quickly and moderate temperatures.

PPCC would like to thank RMC for inviting the club to the function and a special thanks to Christy for furnishing the space.

A Publication of:



**THE NEXT MEETING OF PPCC
WILL BE AUGUST 26, 1998
AT THE NCOA CLUBHOUSE**

TIME: 6:30pm

A Chapter of:



PIKES PEAK CORVAIR CLUB
OFFICERS 1998

PRESIDENT
VICE PRESIDENT
SECRETARY
TREASURER
DRIP LINE EDITOR

LARRY NEAL 570-9694
GARRIE FOX 596-5051
RUTH GOODMAN (303) 934-5027
JOHN KOLL 593-1928
STEVE GOODMAN (303) 934-5027
e-mail rearengine.steve@worldnet.att.net

MEMBERSHIP BEN BENZEL 598-6886
All correspondence To PIKES PEAK CORVAIR CLUB or it's officers should be mailed to PO Box 15034, Colorado Springs, Colo. 80935.

The DRIPLINE is a monthly publication of the PIKES PEAK CORVAIR CLUB, a non-profit organization. Deadline for submitting information to the DRIPLINE is the first Tuesday of each month for that month's publication.

Business card size ads, advertising business services of both members or non-members are \$2.50 per month. To save time and money, advertisers are asked to send \$15.00 for six (6) months or \$30.00 for one year of advertising. Send your advertising check to PIKES PEAK CORVAIR CLUB, INC. PO BOX 15034, COLORADO SPRINGS, COLO. 80935.

Simple classified advertising of CARS FOR SALE or PARTS FOR SALE or WANTED are free to members, non-members will be charged \$2.50 per issue.

GREETINGS

Well, just got back from Rocky Mountain Corsa's picnic and was it great!! Thanks to Laura Wilshire for inviting us and Christy Barden for hosting. We have some great food and company as well as a fine swap meet.

Remember this month is our picnic meeting, the club supplies the hamburgers, brauts, drinks and all we ask is that you bring a side dish or dessert and \$2.00 each to cover part of the food costs.

This is one of our biggest meetings, plan on attending and get re-acquainted with old friends.

See you there!!

Larry

UPCOMING EVENTS FOR PPCC

The end of summer is getting close. The normal early fall activities include such things as a drive to Canon City (Belvedere Restaurant) for Italian food and an aspen tour. Sometimes the club has sponsored a tech session on a Sunday too.

Since these ideas have all been used before, perhaps some of the members would like to suggest someplace to go or something different to do. Please let Larry Neal or any of the officers in on your ideas, all PPCC members would like a change of pace.

Also, since fall is coming, that means winter can't be far behind. We should start thinking about where the Christmas party should be this year and along with the party is election of officers. If any of you reading this would like to take the plunge and be an officer of PPCC let Larry know. In fact I think this is the year that the Vice President moves onward and upward and relieves Larry of his duties. If this is the case then PPCC definitely needs a new VP.

A TOUCH of CLASS

Professional Detailing

229 N. Cascade, Colorado Springs, CO. 80903

Fine Detailing
At It's Best



*We also specialized in
Classic, Antique &
Street Rod Detailing.*

For Appointment call
(719) 448-9313

Michael Wiltrout

Advanced Friction Technologies, Inc.

Manufacturer & Distributor
RK-44 Oil Additive Products



J.B ISAAC
President/C.E.O



3333 C. North El Paso St.
Colorado Springs, CO 80907

(719) 578-5588
Fax (719) 578-9952
(800) TRY-RK44
<http://www.rk44.com>

MEETING MINUTES

The July meeting of PPCC was called to order by President Larry Neal at 7:45pm. There were 11 members present. There was no treasurers report but the club is solvent.

OLD BUSINESS: The picnic sponsored by RMC was discussed. It will be held at Christy Bardens in Boulder on August 9. Also our club picnic/meeting on August 26 was discussed.

NEW BUSINESS: A short discussion of upcoming events was held.

ENTERTAINMENT: A video of Buena Vista was shown, followed by door prizes.

Lastly, a count was kept by the secretary, Garrie Fox and Mark King each had two pieces of cake but Larry Neal claimed to have eaten 5 pieces. If more members would attend there would be less cake for each person.

Meeting was adjourned at 8:15. *(thank you Ruth for the cake, ed)*

Respectfully submitted, Ruth Goodman Secretary

CARS FOR SALE

1963 CORVAIR SPYDER, 2dr 4speed in good condition. Engine runs great, with a rebuild in 1983 and has about 2500 miles over the last 15 years. \$1800.00 FIRM. Call Jim DeBolt @ (719) 481-2663 (paid ad)

1963 CORVAIR SPYDER convertible. Car is located in Saratoga, Wyo. Brown out/tan in. Runs, older restoration, odometer broken, reads 48,000 miles. Was repossessed and repo title available. Offers accepted by sealed bid and reserve right to refuse bid. Call Dan for more info. Day (307) 326-8314 or evening (307) 326-5302 (paid ad)

1965 MONZA 4dr sedan, 140pg with Milt Binion fuel injection installed. Also operational Air Conditioning, full tinted windows, tele-wood wheel, four-way flashers and CORSA dash with pg selector mounted properly at the edge of the dash. The fuel injection allows this car to start instantly in any weather and after sitting for several weeks. \$2900.00 obo. Call Garrie Fox @ 596-5051 for a demonstration.

CORSA INTERNATIONAL CONVENTION

PPCC members Laura Wilshire and Dale and Joan Wilshire took Laura's 64 spyder convertible to St. Louis. Laura had entered the Ed Cole competition so she was to compete in every event. Also RMC members Harlan Colburn Jr and Sr attended with their CROWN Corveight slalom race car and Leon and Keturah Brown from Boulder took parts to sell. Larry Neal's brother David and his father John attended a part of the meet too.

The bright side of all this was the race car: Harlan Colburn Jr drove to FTD at both the big track called GATEWAY as well as the autocross. The car has a 383 ci small block in the back seat and weighs about 1800 lbs.

The down side was the weather on concourse day. Lightning and very heavy rain along with the fact that there was no indoor place to put the cars caused the complete cancellation of the concourse. Bad luck plagued both Laura, who had brought a flu bug with her from Boulder and father Dale who suffered some heat exhaustion and had to be hospitalized for a short time.

The cancellation and the accusations that the club should have had contingency plans for the concourse and even complaints that the autocross was too short have used a lot of bandwidth on VIRTUAL VAIRS.

Next year the convention will be at Lake Tahoe in June.

Your editor would like to take this opportunity to say CONGRATULATIONS to the Colburns and say that I am genuinely saddened by the Wilshire families vain attempt, as I am sure all of PPCC would agree.

UPCOMING EVENTS FOR 1998

- AUGUST 26-----AUGUST PICNIC meeting of PPCC at the clubhouse. Beginning at 6:30pm. PLEASE ATTEND, this is an event to sit around and visit with other CORVAIR folks and have some good food
- AUGUST 29-----CRUISE @ GUNTHER TOODY'S---See flyer in this issue
- SEPTEMBER 13-----Brunch at Barrons, please call Larry Neal for resevations
- SEPTEMBER 19-----8th annual JAMES DEAN DAZE in Limon, Colo See flyer in this issue

JOIN CORSA ONLY \$35.00/YEAR TO KEEP OUR CARS ALIVE

Kusy's
AUTO TRIM

MICHAEL KUSY
 OWNER

AUTOMOTIVE AND MARINE UPHOLSTERY



BOAT TOPS & COVERS

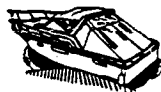

3116 ILLINOIS
 COLORADO SPRINGS, CO

633-8174

From one Corvair lover to another...

CORVAIRS

by

CREATIVE STITCHES
 2710 Cancun Court
 Grand Junction, CO 81506
 (970) 245-4722

MEMBER of CORSA/TUCSON CORVAIR ASS'N
 PIKES PEAK CORVAIR CLUB
 e-mail mr-mrsvair@juno.com



GARRIE L. FOX
 M.A. RESOURCE MGMT.
 BROKER ASSOCIATE
 5265 N. Academy Blvd., #3300
 Colorado Springs, CO 80918
 Office: (719) 548-0400
 Fax: (719) 548-9475
 Home: (719) 596-5051

HERITAGE
REALTORS

S O L D O N C O L O R A D O



FINANCIAL SERVICES

Greg Bianchi
 Registered Representative

Investments

- * *Mutual Funds*
- * *Annuities*
- * *IRA's*
- * *Tax Free*
- * *C.D. Alternatives*

Tax Consulting

- * *Business*
- * *Personal*

Life Insurance

- * *Term*
- * *Universal*
- * *Keyman*
- * *Buy / Sell*

Bus: 719-635-7761 WATS 800-366-7935

320 W. Fillmore, Suite 114
 Colorado Springs, CO 80907-6065

All Securities Offered Through InterSecurities, Inc.
 An Aegon USA Company
 Member National Association of Securities Dealers, Inc.
 SIPC and SEC Registered Investment Advisor

MEMBERSHIP AND DUES

The following named PPCC members have dues **NOW DUE** or are **PAST DUE!!** If your name appears below, it is time to get your check to us. Instead of mailing it, bring it to our annual picnic on the 26th of August. If you cannot attend the picnic, mail to the following address: PPCC, PO Box 15034 C/Springs, Colo 80935. Dues are only \$15.00 per year and we need and appreciate your support. Questions, call Ben @ 598-6886.

Marshall Hesler	8/98	*L. Roseburrow	7/98
Sidney Jones	8/98	John Smith	8/98
Jerry Murphey	8/98	*Carl White	7/98
Larry Neal	8/98		

***FINAL NOTICE--Please remit this month or NO MORE DRIPLINE**

Ben Benzel, membership chairman

WEDDING ANNOUNCEMENT

PPCC received an invitation from club member **Misty Decker** in Rifle, announcing the wedding of her and long time beau **Jack Stuart**. The date is September 5th but sadly by the time the invitation would be announced to the membership the RSVP time has lapsed.

SO, since all 60 members cannot attend, PPCC would like to say congratulations and all the best for the rest of your lives. Hopefully the two of you can attend one of our events in the future so we may say **"GOOD LUCK"** in person.

WE'RE YOUR
DISCOUNT
CORVAIR PARTS
FOR THE 90'S AND BEYOND!



SERVICE
SELECTION
SATESFACTION
SIMPLE!

FOR 23 YEARS WE'VE BEEN SUPPLYING CORVAIR OWNERS WITH THE PARTS THEY NEED - ALL AT THE BEST DISCOUNT PRICES! REPRODUCED PARTS, USED PARTS, REBUILDING SERVICES - WE HAVE IT ALL! BEFORE YOU BUY MAKE SURE TO CHECK US OUT - 30 DAY NO-RESTOCKING, ONE YEAR GUARRANTEE ON MOST PARTS AND SERVICES. FAST, SAME DAY SERVICE. ALL MAJOR CREDIT CARDS ACCEPTED. TOLL FREE ORDER NUMBER (1-800-825-8247). GIANT SELECTION!

ORDER OUR GIANT MAIL ORDER CATALOG - THE CORVAIR BOOK - \$5.00 NOW REFLINDABLE WITH FIRST ORDER OF \$100.00 OR MORE!

ALSO MAKE SURE YOU'RE ON OUR SUBSCRIPTION LIST FOR OUR FREE NEWSLETTER - THE CORVAIR NEWS WE NEED YOUR NAME & ADDRESS!

CORVAIR UNDERGROUND INC
PO BOX 339 DUNDEE, OR 97115
1-503-434-1648 9-5 M-F
FAX 1-503 434-1648
WWW.CORVAIRUNDERGROUND.COM



8th Annual James Dean Daze

Classic Car Show September 19, 1998

sponsored by
Limon Promotions Council
P.O. Box 55
Limon, Colorado 80828
719/775-2874

Official Vehicle Entry Form

Complete and Mail to: Limon Promotions Council, JDD, P.O. Box 55, Limon, CO 80828.
The 8th Annual James Dean Daze is open to vehicles of any year. Your registration packet will be available the day of the event.
Classes: Antique Original, Classic Original, Custom, Muscle Car Original, Street Rod, Truck; 1st & 2nd Place in each Class.

Entry Fee: \$15.00: Provides entry for one car, one dash plaque for first 100 cars, and various coupons from area businesses. Must be present for awards.

Please Print:

Name: _____ Phone: _____

Address: _____

City, State, Zip: _____

Car: Year: _____ Make: _____

Body Style: _____ Club: _____

Entrant must be 18 years of age. If not, Parent or Legal Guardian must sign.

Liability: In consideration of the acceptance of the right to participate, entrants, participants, and spectators, by execution of this entry form expressly release Limon Promotions Council, James Dean Daze, the Town of Limon and its officers, and anyone else connected with management or presentation of the 8th Annual James Dean Daze of or from any and all known or unknown damages, injuries, losses, judgments, and/or claims from any causes whatsoever that may be suffered by any entrant to his person or property. Further, each entrant expressly agrees to indemnify all of the foregoing entities, firms, persons, and bodies of any form from any and all liability occasioned or resulting from the conduct of entrants or any participant assisting or cooperating with entrant and under the direction or control of the entrant.

I have read and agree to all conditions of the 8th Annual James Dean Daze and rules governing the event as set forth on this form and agree to observe all rules and decisions of event management.

Entrant: _____

If Under 18, Guardian: _____

Date Signed: _____

Phone: _____

Judging Class (Circle One):

Antique Original

Classic Original

Custom

Muscle Car Original

Street Rod

Truck

FOR MORE INFORMATION CALL LINDA, 719-775-2874.
For vendor applications, call 719-775-2874.

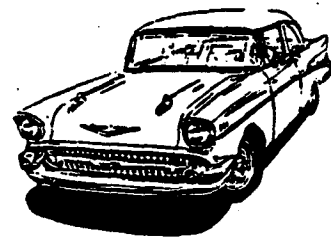
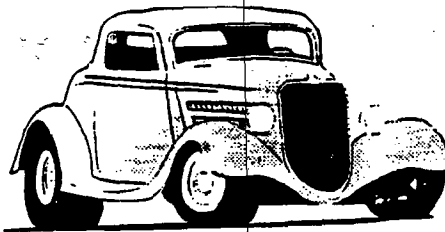
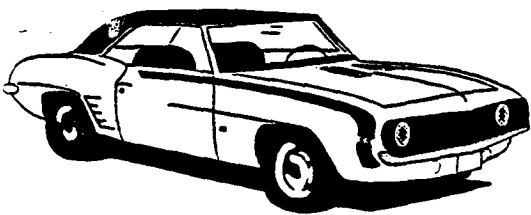

GUNTHER TOODY'S DINER

PRESENTS:

THE 1st ANNUAL COLORADO SPRINGS CRUISE-A-RAMA OPEN CAR SHOW

(No registration required)

SATURDAY, AUGUST 29th

10:00am. to 2:00pm.

100's OF COLORADO'S COOLEST CARS... DADDY'O

FUN AND GAMES FOR THE KIDS

PLENTY OF GREAT FOOD

DISC JOCKEY AND COOL TUNES ALL DAY LONG

DOZENS OF DOOR PRIZES

WEST OF THE GUNTHER TOODY'S DINER

AT N. ACADEMY and AUSTIN BLUFFS



REAR-ENGINE SPECIALISTS
 16010 W. 5th Ave. Unit 12
 Golden, Colo. 80401



Steve Goodman

(303) 278-4889 Fax (303) 936-7420

INTERSTATE BATTERIES
 INTERSTATE BATTERY SYSTEM OF SOUTHERN COLORADO
 222 E. CUCHARRAS • COLORADO SPRINGS CO 80903

C. Max Clark
 Owner/Operator

(719) 577-4548
 FAX (719) 578-8114

NCOA

Service Center

 3930 Encino Dr.
 Colorado Springs, CO 80918

E.L. "Ben" Benzel
 Senior Master Counsellor

Bus.: (719) 599-9725
 Fax: (719) 540-8387
 Res.: (719) 598-6886



AGENT FOR
ACADEMY LIFE
 A PROVIDIAN Insurance Company

WRECKMASTERS
 BODY & FRAME

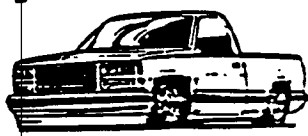

Jim J. Keeney
 Owner

315 So. 14th St.
 Colorado Springs, CO 80904
 (14th & Cimarron, H-Way 24)

Bus. 520-1184
 Res. 634-7378

Quality Collision Repair & Painting

THE DRIPLINE
 Pikes Peak Corvair Club
 PO Box 15034
 Colorado Springs, Co.
 80935

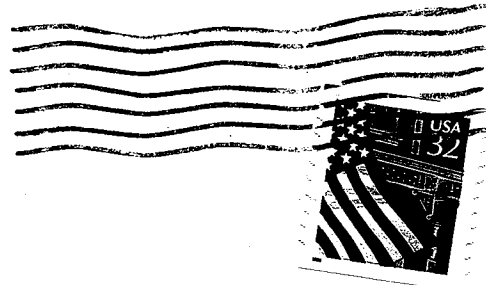

SEND TO:

Walter Hundertmark
 15 El Paso Blvd #26
 Manitou Spgs, Co 80829

THE

DRIP LINE

VOL. 21
NO. 12 SEPTEMBER 1998

HAPPY BIRTHDAY PPCC 22 YEARS OF A CORVAIR LOVE AFFAIR

PICNIC IS SUCCESSFUL, WILL THE BIRTHDAY DRIVE?

The annual potluck picnic meeting in August was an attendance success. 43 members and their families attended, making this the largest number of any PPCC event this year. Can we remain on a roll now and have a large turnout for the drive to the Belvedere this month? Hopefully the answer will be yes.

On September 27 we will meet in the parking lot of DENNY'S on Bijou and I-25 at 1:00pm. There will be a drive through the mountains past some hopefully colorful aspens. Sadly MOTHER NATURE does not have a really firm schedule on when the changing will take place so PPCC members will have to take a chance that day.

The BELVEDERE in Canon City is renowned for its' Italian food. In the past PPCC has always gotten very good service, the food is good and the prices are fair. Also there will be a BIRTHDAY CAKE to help PPCC celebrate its' 22nd year in existance. Get in your CORVAIR and drive with us into the mountains.

Since the NCOA Clubhouse is occupied for the normal meeting night in October, the possibility exists for another Sunday outing and that will include a tour of something to be announced, a place for a late lunch and a very brief meeting. PLEASE NOTE that in November, the fourth Wednesday always is the day before THANKSGIVING, the PPCC meeting has been traditionally moved back to the 3rd Wednesday in November. Watch the DRIPLINE for details about these changes.

A Publication of:

NOTICE

A Chapter of:

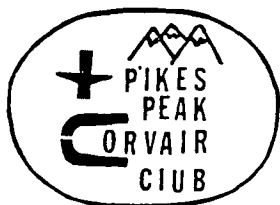

**THE SEPTEMBER MEETING WILL BE
INCLUDED IN THE DRIVE TO
CANON CITY ON
SEPTEMBER 27**



PIKES PEAK CORVAIR CLUB
OFFICERS 1998

PRESIDENT
VICE PRESIDENT
SECRETARY
TREASURER
DRIP LINE EDITOR

LARRY NEAL
GARRIE FOX
RUTH GOODMAN
JOHN KOLL
STEVE GOODMAN

570-9694
596-5051
(303) 934-5027
593-1928
(303) 934-5027

MEMBERSHIP

e-mail rearengine.steve@worldnet.att.net
BEN BENZEL 598-6886

All correspondence To PIKES PEAK CORVAIR CLUB or it's officers should be mailed to PO Box 15034, Colorado Springs, Colo. 80935.

The DRIPLINE is a monthly publication of the PIKES PEAK CORVAIR CLUB, a non-profit organization. Deadline for submitting information to the DRIPLINE is the first Tuesday of each month for that month's publication.

Business card size ads, advertising business services of both members or non-members are \$2.50 per month. To save time and money, advertisers are asked to send \$15.00 for six (6) months or \$30.00 for one year of advertising. Send your advertising check to PIKES PEAK CORVAIR CLUB, INC. PO BOX 15034, COLORADO SPRINGS, COLO. 80935.

Simple classified advertising of CARS FOR SALE or PARTS FOR SALE or WANTED are free to members, non-members will be charged \$2.50 per issue.

NOTES FROM THE PRESIDENT

First off I would like to thank all 43 members and their families that attended the picnic in August. That was the highest attended meeting in some time, maybe we should have a picnic every month. The food was very good and everyone appreciates the hard work that the wives put forth to make their favorite dish, they were all very tasty! ALSO, thanks to Ben Benzel for doing the leg work picking up the hamburgers and brauts and of course for furnishing the clubhouse and its facilities for the cookout. Plus the weather was the best it has been in several years.

In September it was decided to do the usual drive to the Belvedere in Canon City for Italian food and a look at some scenery along the way. This will also double as the September meeting. We will meet at Denny's on Bijou and I-25 and leave at 1:00pm for a liesurely drive to Canon City. Please let me know if you are going so the restaurant can have enough seats and tables. Thank you.

It was also discussed at the picnic meeting the upcoming events such as the Christmas party and elections. I think we have everything fixed until the end of the year.

ONE NOTE OF INTEREST--In October the clubhouse will NOT be available for usage. We will find something to do and you will be notified in the OCTOBER DRIPLINE.

Hope to see you all at the drive to CANON CITY on September 27.

Larry Neal, president

A TOUCH of CLASS

Professional Detailing

229 N. Cascade, Colorado Springs, CO. 80903

Fine Detailing
At It's Best



*We also specialized in
Classic, Antique &
Street Rod Detailing.*

For Appointment call
(719) 448-9313

Michael Wiltrout

Advanced Friction Technologies, Inc.

Manufacturer & Distributor
RK-44 Oil Additive Products



J.B ISAAC
President/C.E.O



3333 C. North El Paso St.
Colorado Springs, CO 80907

(719) 578-5588
Fax (719) 578-9952
(800) TRY-RK44
<http://www.rk44.com>

**THE SEPTEMBER MEETING WILL BE HELD AT THE BELVEDERE IN
CANON CITY ON SEPTEMBER 27. COME, JOIN THE DRIVE**

MEETING MINUTES

The August meeting was the annual picnic affair on August 26. The meeting began at 6:00pm with the picnic dinner. Afterward a short business meeting was held. There were 43 members present. Larry Neal announced the September event, a combination PPCC Birthday celebration, aspen tour monthly meeting and dinner at the Belvedere in Canon City. See the DRIPLINE for details. The Christmas party was discussed also, the same place as last year. Larry said he would take care of the reservations. Elections were also briefly discussed, the elections for 1998 will be at the Christmas party.

The proper thanks to the cooks, Ben Benzel for obtaining the hamburgers and brauts, soft drinks and making sure that the clubhouse was available and all the folks who brought goodies were made, door prize drawings were held.

Respectfully submitted, Ruth Goodman, secretary

PPCC MEMBERS AND E-MAIL

Vice President Garrie Fox suggested that all PPCC members with an electronic mail address be listed in the DRIPLINE and also would be a good and fast tool to notify said members of changes or needs without using the telephone. If you have an e-mail address that you don't mind publishing, tell Garrie or the editor. After this month, the address list will be updated each month and the address will also be added to the roster.

Larry Neal larryn@col.hp.com
Garrie Fox Gfox@kktv.com
Steve Goodman rearengine.steve@worldnet.att.net
Ben Fulcher vefulcher@uswest.net
Ken Brown krbrown@bewellnet.com

A SAD NOTE

Your editor received an e-mail post from John Hesco in Greybull, Wyo; John said that his wife Vera had passed away. John and Vera started coming to the Tri-state meets in Gunnison and joined PPCC at that time. Vera was a pretty active lady and will be missed.

PPCC IS 22 YEARS OLD

PPCC is 22 years old in September of 1998. There are several scrapbooks at the NCOA clubhouse that have pictures and articles from the beginning days. Probably the longest members still in PPCC today would include Walter Hundertmark, Jim and Pat Wood, Sid Jones, John Dowswell, Ed Malew, John and Dee Glusik and John Koll. Hopefully I haven't left anyone out of that elite group, Your editor is looking at the roster and trying to remember who were in the club when I first started. I certainly don't want to slight anyone, if you were in the original group let me know.

CARS FOR SALE

1963 CORVAIR SPYDER convertible. Car is located in Saratoga, Wyo. Brown out/tan in. Runs, older restoration, odometer broken, reads 48,000 miles. Was repossessed and repo title available. Offers accepted by sealed bid and reserve right to refuse bid. Call Dan for more/info. Day (307) 326-8314 or evening (307) 326-5302 (paid ad)

UPCOMING EVENTS FOR 1998

- SEPTEMBER 27-----PPCC drive to Canon City plus the monthly meeting. Meet at Denny's at I-25 Bijou at 1:00pm. Call Larry Neal for reservations 570-9694
- OCTOBER 11-----2nd Sunday Brunch at Barrons, Airport and Academy. All PPCC members welcome. Call Larry Neal for reservations 570-9694
- OCTOBER 23-----Monthly meeting of PPCC, location to be announced!!! Watch the DRIPLINE next month for details.
- DECEMBER-----Annual Christmas party and elections. Vote early, Vote often

JOIN CORSA ONLY \$35.00/YEAR TO KEEP OUR CARS ALIVE

Kusy's
AUTO TRIM

MICHAEL KUSY
OWNER

AUTOMOTIVE AND MARINE UPHOLSTERY

BOAT TOPS & COVERS



3116 ILLINOIS
COLORADO SPRINGS, CO

633-8174

From one Corvair lover to another...

CORVAIRS

by

CREATIVE STITCHES
2710 Cancun Court
Grand Junction, CO 81506
(970) 245-4722

MEMBER of CORSA/TUCSON CORVAIR ASS'N
PIKES PEAK CORVAIR CLUB
e-mail mr-mrsvair@juno.com

GARRIE L. FOX
M.A. RESOURCE MGMT.
BROKER ASSOCIATE
5265 N. Academy Blvd., #3300
Colorado Springs, CO 80918
Office: (719) 548-0400
Fax: (719) 548-9475
Home: (719) 596-5051

H **HERITAGE**
REALTORS

S O L D O N C O L O R A D O



**FINANCIAL
SERVICES**

Greg Bianchi
Registered Representative

Investments

- * *Mutual Funds*
- * *Annuities*
- * *IRA's*
- * *Tax Free*
- * *C.D. Alternatives*

Tax Consulting

- * *Business*
- * *Personal*

Life Insurance

- * *Term*
- * *Universal*
- * *Keyman*
- * *Buy / Sell*

Bus: 719-635-7761 WATS 800-366-7935

320 W. Fillmore, Suite 114
Colorado Springs, CO 80907-6065

All Securities Offered Through InterSecurities, Inc.
An Aegon USA Company
Member National Association of Securities Dealers, Inc.
SIPC and SEC Registered Investment Advisor

21st ANNUAL GREAT WESTERN FAN BELT TOSS & SWAP MEET

NOVEMBER 6-7-8, 1998, Palm Springs, CA

OFFICIAL USE ONLY

Date Received _____

Check Number _____

Amount Rec'd _____

HOSTED BY THE SAN DIEGO CORVAIR CLUB IN JOINT VENTURE WITH CORSA WEST OF LOS ANGELES, COYOTE CORVAIR CLUB, INLAND EMPIRE CORVAIR CLUB, AND VINTAGE CORSA.

NAME _____ SPOUSE _____
 (PLEASE PRINT NAMES AS YOU WISH THEM TO APPEAR ON NAME TAGS)

STREET ADDRESS _____

CITY _____ STATE _____ ZIP _____

CORSA CHAPTER AFFILIATION _____

CANDIDATES FOR "LONGEST DISTANCE" AWARD - MILEAGE _____ (DRIVEN CORVAIR VEHICLES ONLY)

CANDIDATES FOR "OLDEST ATTENDEE" AWARD - AGE _____

	QUANTITY	PRE-REG FEE	ON SITE FEE	SUB-TOTAL
FAMILY REGISTRATION	___1___	___\$5.00___	___\$10.00___	\$ _____
RV SPACE (FRIDAY & SATURDAY NITES ONLY)	_____ NITES	___\$12.50/NITE___	___\$17.50/NITE___	\$ _____
WELCOME PARTY AT HOST HOTEL FRI NITE. NO CHARGE, BUT NEED HEADCOUNT _____ PERSONS				
ENTRY IN "AMERICA'S CUP TIME TRIALS" AT HOST HOTEL FRI NITE. NO CHARGE _____ ENTRIES				
BANQUET				
PER ADULT	_____ #	___\$25.00___	___\$30.00___	\$ _____
PER CHILD	_____ #	___\$13.00___	___\$18.00___	\$ _____
SWAP MEET SPACE (20' X 20') ENTIRE WEEKEND	_____ #	___\$12.00___	___\$20.00___	\$ _____
COMMERCIAL VENDORS	\$8.25 PER DAY CITY LICENSE FEE.		_____ #DAYS	\$ _____

(FEE AND RESALE NUMBER REQUIRED) _____ RESALE NUMBER _____
 ALL VENDORS NOTE: IF YOU WISH TO BE LOCATED NEAR OTHER VENDORS, PLEASE LIST THEIR NAMES ON BACK.

PEOPLE'S CHOICE CAR SHOW	PER VEHICLE	_____ #	___\$5.00___	___\$10.00___	\$ _____
MODEL CAR CONTEST	PER ENTRY	_____ #	___\$2.00___	___\$3.00___	\$ _____
"CREATIVE PARTS" CONTEST	PER ENTRY	_____ #	___\$2.00___	___\$3.00___	\$ _____
TOTAL AMOUNT					\$ _____

PLEASE NOTE: ALL RESERVATIONS WILL BE ACCEPTED AND CONFIRMED ON A FIRST-COME-FIRST-SERVED BASIS. THE NUMBER OF PARTICIPANTS AND/OR ENTRIES IN ANY GIVEN EVENT MAY BE LIMITED.

MAKE ALL CHECKS PAYABLE TO : "SDCC GWFBT&SM" MAIL TO: GWFBT&SM, P O BOX 609, POWAY, CA 92074.

PRE-REGISTRATION DEADLINE IS OCTOBER 27, 1998

GREETINGS TO ALL CORVAIRISTS!!

- Welcome to the 1998 Great Western Fan Belt Toss & Swap Meet's information and registration process. This year we are beginning a new era of Fan Belt Tossing by integrating the efforts and energies of five CORSA Chapters – CORSA WEST OF LOS ANGELES, COYOTE CORVAIR, INLAND EMPIRE, SAN DIEGO (primary host this year), and VINTAGE CORSA. It is our common goal that all future GWFBT&SMs be conducted in this co-operative manner.
- Listed below is information which we believe will assist you in making your registration selections. **PLEASE READ THE FOLLOWING CAREFULLY** so that your hosting committees may better serve you.
- **HOTELS:** This year we have blocked rooms in two excellent but moderately priced properties. They are 1.9 miles from Pavilion Field, where most activities occur. Our host hotel will be the OCOTILLO LODGE, located at 1111 East Palm Canyon Drive, Palm Springs 92264, (760) 416-0678 and fax (760) 416-0599. "Host" this year means that the OCOTILLO will be the site of the Welcome Party on Friday evening, and that 60 full condo-type suites, with kitchens, have been blocked for our use. The rate is \$65 + 10.75% local and state taxes. Some rules apply:
 - * CUT-OFF DATE for our special rate is October 16th. First night's lodging is due at cut-off; balance on check out.
 - * CANCELLATION without penalty is 72 hours prior to arrival; for most attendees, that's November 3rd.
- The QUALITY INN is the second hotel offered. It is separated from the Ocotillo only by two restaurants, JEREMIAH'S STEAK HOUSE and CARROW'S. The QUALITY is at 1269 East Palm Canyon Drive, (760) 323-2775 or fax (760) 323-4234. A total of 75 rooms have been blocked for us at a rate of \$59 + 10.75% taxes. All rooms have guest coffee; refrigerators and microwaves are available upon request.
- RESERVATIONS AT THESE OR ANY OTHER HOTELS ARE YOUR RESPONSIBILITY. No hotel reservations will be made by the GWFBT&SM host committee.
- **RESTAURANTS:** In addition to the two mentioned above, several other very good restaurants are within easy walking distance of the two hotels. And you probably know that Palm Springs and vicinity offers many other excellent eateries.
- **FRIDAY NIGHT WELCOME PARTY:** As is our usual custom, a "mixer" party will take place Friday at the OCOTILLO LODGE from 7:30 to 11 p.m. There will be NO CHARGE for the Welcome Party. Soft drinks, coffee, and "nibblings" will be the offerings at the beautiful pool area, and guests are free to BYOB. However, **NO GLASSWARE IS PERMITTED** in the pool area (we will provide plastic). Alcoholic beverages are also available at JEREMIAH'S Steak House's bar adjacent to the OCOTILLO ; just a skip away!
 - Note: The treats we will offer are not intended to substitute for dinner! Please plan to dine prior to the party.
 - The ever popular AMERICAS' CUP TIME TRIALS will take place in the hotel pool from 8:30 to 9:30 p.m. You may enter any type of floatable, radio-controlled conveyance capable of navigating the course! VINTAGE CORSA will officiate.
- **PRE-REGISTRATION PACKETS AND "WALK-UPS":** If you register prior to the OCTOBER 27 PRE-REG DEADLINE, your packets will be available at the entrance to the field on Friday morning beginning around 10 o'clock. The Registration Committee will staff this location until late afternoon Friday, and will set up again at the Welcome Party at the OCOTILLO LODGE at 7:30 p.m. Packets will again be available from early Saturday morning until late afternoon at the field.
 - Walk-up registrations may also be made at any of the above times, but the fee structure is significantly higher.
- **EVENT PRICING – PRE-REG VS "WALK-UP":** It should be clear to everyone that this event must remain solvent or it will shortly become a thing of the past. That factor was one of the many which prompted the integration of efforts of the sponsoring CORSA chapters. Expenses associated with virtually every activity at the GWFBT&SM increase substantially when attendees fail to register in a timely manner. Therefore, we ask you to PLEASE PRE-REGISTER prior to the OCTOBER 27th DEADLINE.
- **PAVILION FIELD (PRACTICE FIELD) ACTIVITIES:** From Friday noon until Sunday noon the practice field next to the baseball park will be open for GWFBT&SM activities. Limited RV parking is available on the field (two nights only), and most other events are centered at the field.
 - Field events include the People's Choice Car Show, Fan Belt Toss and other games, Creative Parts and Model Contests, field raffles, raffle ticket sales, t-shirt and Corvaire merchandise vending, and the absolutely LARGEST AND MOST COMPREHENSIVE CORVAIR SWAP MEET AND FLEA MARKET IN THE ENTIRE WORLD.
 - A couple of important Palm Springs City regulations: NO DOGS ARE PERMITTED on the field at any time, and NO TRAFFIC OF ANY KIND is permitted on the BASEBALL INFIELD (which will be taped off).
 - Several Porta-potties will be placed around the field perimeter to augment the city owned public rest rooms. These are for use by all attendees, including the RVers.
 - Message Board facilities, PA announcements and swap-meet space locator services will all be available.

MEMBERSHIP AND DUES

The following named PPCC members have dues **NOW DUE** or are **PAST DUE!!!** If your name appears below, it is time to get your check to us. Our mailing address is PPCC, PO BOX 15034, Colorado Springs, Colo. 80935. Dues are \$15.00 per year and we need and appreciate your support. Questions, call Ben @ 598-6886.

Ellen Fisher 10/98
 Garrie Fox 10/98
 John Glusick 10/98
 Ron Lezon 10/98

***Jerry Murphy** 8/98
 Larry Neal 9/98
***John Smith** 8/98
 Bill Mattics 10/98

***FINAL NOTICE** Please remit NOW or **NO MORE AWARD WINNING DRIPLINE!!** (?? ed.)

Ben Benzel, membership chairman

WELCOME NEW MEMBERS

We want to give a big welcome to Brad and Cindy Weaver who joined us at our picnic. Brad manages a tire shop in Monument, Colo and Cindy is a server at Gunther Toody's. They have one of those rare 69 2-dr coupes. Their phone is 719 683-6690.

Ben Benzel, membership chairman

JOIN CORSA-ONLY \$35.00 A YEAR TO KEEP OUR CORVAIRS GOING

WE'RE YOUR
DISCOUNT
CORVAIR PARTS
 FOR THE 90'S AND BEYOND!



SERVICE
SELECTION
SATESFACTION
SIMPLE!

FOR 23 YEARS WE'VE BEEN SUPPLYING CORVAIR OWNERS WITH THE PARTS THEY NEED - ALL AT THE BEST DISCOUNT PRICES! REPRODUCED PARTS, USED PARTS, REBUILDING SERVICES - WE HAVE IT ALL! BEFORE YOU BUY MAKE SURE TO CHECK US OUT - 30 DAY NO-RESTOCKING, ONE YEAR GUARRANTEE ON MOST PARTS AND SERVICES. FAST, SAME DAY SERVICE. ALL MAJOR CREDIT CARDS ACCEPTED. TOLL FREE ORDER NUMBER (1-800-825-8247). GIANT SELECTION!

ORDER OUR GIANT MAIL ORDER CATALOG - THE CORVAIR BOOK - \$5.00 NOW REFLUNDABLE WITH FIRST ORDER OF \$100.00 OR MORE!

ALSO MAKE SURE YOU'RE ON OUR SUBSCRIPTION LIST FOR OUR FREE NEWSLETTER - THE CORVAIR NEWS WE NEED YOUR NAME & ADDRESS!

CORVAIR UNDERGROUND INC
 PO BOX 339 DUNDEE, OR 97115
 1-503-434-1648 9-5 M-F
 FAX 1-503 434-1648
 WWW.CORVAIRUNDERGROUND.COM





REAR-ENGINE SPECIALISTS
 16010 W. 5th Ave. Unit 12
 Golden, Colo. 80401



Steve Goodman

(303) 278-4889 Fax (303) 936-7420

INTERSTATE BATTERIES
 INTERSTATE BATTERY SYSTEM OF SOUTHERN COLORADO
 222 E. CLYBURN - COLORADO SPRINGS CO 80903

C. Max Clark
 Owner/Operator

(719) 577-4548
 FAX (719) 578-8114





Service Center

 3930 Encino Dr.
 Colorado Springs, CO 80918

E.L. "Ben" Benzel
 Senior Master Counsellor

Bus.: (719) 599-9725
 Fax: (719) 540-8387
 Res.: (719) 598-6886



AGENT FOR
ACADEMY LIFE
 A PROVIDIAN Insurance Company

WRECKMASTERS
 BODY & FRAME



Jim J. Keeney
 Owner

315 So. 14th St.
 Colorado Springs, CO 80904
 (14th & Cimarron, H-Way 24)

Bus. 520-1184
 Res. 634-7378

Quality Collision Repair & Painting

THE DRIPLINE
 Pikes Peak Corvair Club
 PO Box 15034
 Colorado Springs, Co.
 80935

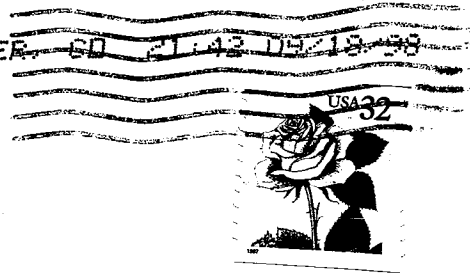
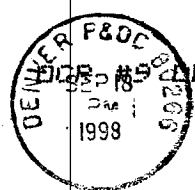

SEND TO:

Walter Hundertmark
 15 El Paso Blvd #26
 Manitou Spgs, Co 80829



THE

VOL. 22
NO. 1 OCTOBER 1998

DRIP LINE

GREAT ASPEN VIEWING FOR OUR BIRTHDAY DRIVE

Six CORVAIRS met at Denny's on September 27 for our annual aspen tour/birthday drive. Included in that group were Larry Neal, John and Phyllis Neal, Ben and Vesta Fulcher, Garrie Fox and navigator Bernice, Jan Patton and Steve and Ruth Goodman. Jan Patton is a new member to PPCC and drove from Kim, Colorado to join us. Kim is about 150 miles from C/Springs. Everyone starting out was in a CORVAIR.

We stopped on Wilkerson Pass and hit the weekend timing pretty well, there was a lot of color change on top of the pass. There were also a lot of other drivers and motorcycle riders there and some had comments about the CORVAIRS.

As we neared Canon City, Doug and Kelly Higgins were waiting for us, also in a CORVAIR and followed us into the Belvedere. Sitting in the restaurant were John and Dee Glusik from Penrose. The food and short meeting were enjoyable. Afterward, Ruth brought out the birthday cake to help PPCC celebrate 22 years. The cake was paid for by Jim and Pat Wood who were among the founding members of PPCC and a short e-mail was read addressed to the club from Jim and Pat. Thank you both, sorry you could not have been present to share in the cake you bought.

OCTOBER MEETING WILL INCLUDE A TOUR

The October meeting of PPCC will be held on the 25th. The clubhouse is booked on the normal Wednesday evening for Halloween.

The program for the meeting will start at DENNYs on I-25 & Bijou at 9:00am. The members will drive to Manitou Springs and tour the PIKES PEAK HILLCLIMB MUSEUM. The entry fee for the museum is \$5.00 each, however **if you drive your CORVAIR, the club will pick up the fee.** If you drive a brand X, then you have to pay.

After the tour we will drive to a restaurant (that hasn't been named yet) for lunch. There may be a short business meeting if space there allows it.

A Publication of:



NOTICE

THE OCTOBER MEETING WILL BE INCLUDED IN THE TOUR OF THE HILLCLIMB MUSEUM ON OCTOBER 25

A Chapter of:



PIKES PEAK CORVAIR CLUB
OFFICERS 1998

PRESIDENT
VICE PRESIDENT
SECRETARY
TREASURER
DRIP LINE EDITOR

LARRY NEAL 570-9694
GARRIE FOX 596-5051
RUTH GOODMAN (303) 934-5027
JOHN KOLL 593-1928
STEVE GOODMAN (303) 934-5027
e-mail rearen@engine.steve@worldnet.att.net
BEN BENZEL 598-6886

MEMBERSHIP
All correspondence To PIKES PEAK CORVAIR CLUB or it's officers should be mailed to PO Box 15034, Colorado Springs, Colo. 80935.

The DRIPLINE is a monthly publication of the PIKES PEAK CORVAIR CLUB, a non-profit organization. Deadline for submitting information to the DRIPLINE is the first Tuesday of each month for that month's publication.

Business card size ads, advertising business services of both members or non-members are \$2.50 per month. To save time and money, advertisers are asked to send \$15.00 for six (6) months or \$30.00 for one year of advertising. Send your advertising check to PIKES PEAK CORVAIR CLUB, INC. PO BOX 15034, COLORADO SPRINGS, COLO. 80935.

Simple classified advertising of CARS FOR SALE or PARTS FOR SALE or WANTED are free to members, non-members will be charged \$2.50 per issue.

NOTES FROM THE PRESIDENT

First I would like to say thanks to those who drove on the aspen tour and BIRTHDAY celebration at the Belvedere. It was a perfect day for a drive in the mountains, too bad that more of the club members could not participate.

I would like to say thanks to Jim and Pat Wood for buying the birthday cake. Your money was well spent, Ruth brought an excellent cake to the restaurant.

The October meeting has been rescheduled a bit. The clubhouse was booked for a Halloween party so it was decided to do a tour of the Pikes Peak Hillclimb Auto Museum. This is located in Manitou. After the tour we will drive to lunch at a restaurant that I haven't found yet but will before the 25th.

I have put some added incentive into this months' meeting. If you drive a CORVAIR to the meeting/tour/lunch then the club will pay the \$5.00 entry fee at the museum. If you drive anything else you will have to pay your own way. Lets see a lot of CORVAIRs in the parking lot.

Remember that elections are close at hand. The office of President is filled by Garrie Fox but that leaves Vice President open. I think that is the only open position but if one of you wants to run for any office, now is the time to step forward.

See you at DENNYs on OCTOBER 25 at 9:00am.

Larry Neal, President

A TOUCH of CLASS

Professional Detailing

229 N. Cascade, Colorado Springs, CO. 80903

Fine Detailing
At It's Best



*We also specialize in
Classic, Antique &
Street Rod Detailing.*

For Appointment call
(719) 448-9313

Michael Wiltrout

Advanced Friction Technologies, Inc.

Manufacturer & Distributor
RK-44 Oil Additive Products



J.B ISAAC
President/C.E.O



3333 C. North El Paso St.
Colorado Springs, CO 80907

(719) 578-5588
Fax (719) 578-9952
(800) TRY-RK44
<http://www.rk44.com>

MEMBERSHIP AND DUES

The following named members have dues **NOW DUE** or are **PAST DUE!!!** If your name appears below, it is time to get your check to us. Our mailing address is: PPCC, PO Box 15034, C/Springs, Colo. 80935 Dues are \$15.00 per year and we need and appreciate your support. Questions, call Ben @ 598-6886.

Garrie Fox 10/98
John Glusik 10/98
Don Richeson 11/98

Laura Wilshire 11/98
Ron Lezon 10/98

Ben Benzel, membership chairman

WELCOME NEW MEMBERS

We want to give a big welcome to Troy Fuhrman, he found us at the brunch at BARRONS on October 11. Troy is stationed at Ft. Carson and drives a 1968 convertible. We hope you enjoy the club.

Ben Benzel, membership chairman

CHRISTMAS GIFT IDEA

A nice gift anytime would be a membership in CORSA--only \$35.00 a year to keep our CORVAIRS going. Call Ben @ 598-6886.

Ben Benzel, membership chairman

WE'RE YOUR
DISCOUNT
CORVAIR PARTS
FOR THE 90'S AND BEYOND!



SERVICE
SELECTION
SATISFACTION
SIMPLE!

FOR 23 YEARS WE'VE BEEN SUPPLYING CORVAIR OWNERS WITH THE PARTS THEY NEED - ALL AT THE BEST DISCOUNT PRICES! REPRODUCED PARTS, USED PARTS, REBUILDING SERVICES - WE HAVE IT ALL! BEFORE YOU BUY MAKE SURE TO CHECK US OUT - 30 DAY NO-RE STOCKING, ONE YEAR GUARRANTEE ON MOST PARTS AND SERVICES. FAST, SAME DAY SERVICE. ALL MAJOR CREDIT CARDS ACCEPTED. TOLL FREE ORDER NUMBER (1-800-825-8247). GIANT SELECTION!

ORDER OUR GIANT MAIL ORDER CATALOG - THE CORVAIR BOOK - \$5.00 NOW REFLUNDABLE WITH FIRST ORDER OF \$100.00 OR MORE!

ALSO MAKE SURE YOU'RE ON OUR SUBSCRIPTION LIST FOR OUR FREE NEWSLETTER - THE CORVAIR NEWS WE NEED YOUR NAME & ADDRESS!

CORVAIR UNDERGROUND INC
PO BOX 339 DUNDEE, OR 97115
1-503-434-1648 9-5 M-F
FAX 1-503 434-1648
WWW.CORVAIRUNDERGROUND.COM



MEETING MINUTES

The September meeting of PPCC began in the parking lot at Dennys at 1:00pm. There were 9 members and 1 guest present. We drove from the Springs to Wilkerson Pass, stopping there for pictures and looking at the scenery.

After leaving the pass, we drove to Hartzel, turned south towards Canon City. On the edge of Canon City 2 more members were waiting and followed on to the restaurant. Once inside the Belvedere 2 more members were waiting. This brought the total attendees to 13 members and 1 guest.

After dinner Ruth brought out the cake to celebrate PIKES PEAK CORVAIR CLUB'S 22nd birthday. The cake was paid for by Jim and Pat Wood, who were among the founding members of PPCC and live in Washington state now. An e-mail post was read by Steve Goodman from Jim and Pat also. (The cake cost Ruth \$23.95, the check was for 25.00)

The ideas surrounding the October meeting change were discussed. Also it was noted that the November meeting will be changed to the 3rd Wednesday of November to miss Thanksgiving.

Meeting was adjourned and all drove home.

Respectfully submitted,
Ruth Goodman, Secretary

CARS FOR SALE

1963 CORVAIR SPYDER convertible. Car is located in Saratoga, Wyo. Brown out/tan in. Runs, older restoration, odometer broken, reads 48,000 miles. Was repossessed and repo title available. Offers accepted by sealed bid and reserve right to refuse bid. Call Dan for more info. Day (307) 326-8314 or evening (307) 326-5302 (paid ad)

1961 CORVAN (no side windows) 80/4. Good engine/transaxle, new tires, new battery, rebuilt master cylinder. Needs brake job. Windshield cracked, some rust by not like a lot of the FCs. \$400.00 obo. Steve @ Rear Engine (303) 278-4889

PARTS WANTED

Working stock radio for my 66 convertible, AM only. Please call Bill Mattics @ (719) 473-4290

A SAD NOTE

Marsh Hesler called your editor last week to inform all of PPCC that Muriel Richeson, wife of Don Richeson passed away a while back. They lived in Montrose and although they did not attend too many of the events they both still drove their CORVAIRS. Our thoughts should go out to Don and the family.

PPCC MEMBERS E-MAIL ADDRESSES

Add member Jan Patton in Kim, Colorado to the list. Her e-mail is: janpat@ria.net
Also Laura Wilshire in Boulder. Her e-mail is: Sir_Lancealot@msn.com

TECH TIPS

I have had two interesting things come into the shop this month. The first was a fresh engine built by a couple of guys with past VW experience and there should be no problems in assembling a CORVAIR engine anyway. They brought the car to me because the rocker arms could not be adjusted quiet. After hearing the engine it sounded like low oil pressure to me, I put a gauge on the engine and there was NO OIL PRESSURE--ZERO! The first things I looked at were the gears and the pressure relief valve to make sure the valve was not stuck open, it was ok. I replaced the gears with a new pair and set the clearance and when I started it, 35psi. HOWEVER, the rockers were still noisy and after just 3 minutes of running the oil pressure was down to zero again. I asked if the galley plugs were in the case, they had paid a machine shop to clean the engine parts and did not even know what I was talking about since VW uses a different idea. Sure enough, when they pulled the engine apart the plugs were missing.

Luckily there is a happy ending to this story, the machine shop bought new bearings, gaskets, oil and other needed parts so the fellows did do ok. The car showed back at the shop a couple of days ago running nice and quiet.

THE MORAL OF THIS STORY: Never assume that the machine shop has cleaned parts properly, assembled them properly etc. Always clean the oil galleys in the crank, case halves, etc yourself. Please note also that I am not finding fault with machine shops, it is just that you should assume the final responsibility before assembling the engine to insure that everything is in place.

The next bit of fun I had was a car barely running and leaking oil like crazy. The owners had replaced the fan bearing themselves and in the course of doing this did not realize that carb gaskets need to be placed on the port in a particular position, the balance tube hoses need to be in place and there is a grand scheme of things having to do with the wires coming from the distributor cap and what happens to the other ends of said wires. Obviously this takes care of the poor running problems but now on to the oil leaks.

Oops, lets go back a step, I should have noted that stock in PERMATEX is now up a few points due to the amount that was used around the carb bases and other places trying to make a seal where the gaskets were out of place. Now that I have said that, you know what I am leading up to with the oil leaks right? There was at least a tube of ULTRA RED around the top cover, they left the clamp that holds the vent tube into the side of the cover off but tried to glue it in place with the silicone. I have handfulls of the stuff that I peeled off of everything including the cylinders, oil cooler, you name it. Needless to say, none of this was helping to stop the oil leaks. SILICONE is NOT for the replacement of gaskets, sorry folks. I peeled long strings of it from inside the engine once I removed the top cover and even found a bunch of it in the oil pickup screen.

MORAL OF THIS STORY: Use gasket sealer such as PERMATEX 3 or very small thin strand of ULTRA and let it skin over before squeezing the two parts together. A bead 1/16" wide and 1/32" high is more than enough to seal two parts together. Also normal silicones are not temperature rated high enough for use in the engines. Only the ULTRA is ok.

A NOTE FROM JIM AND PAT WOOD

It was great to hear from you. We wish we could be there as we love the Belvedere and cake too!

Jim and Pat Wood (enclosed with the note was a check for \$25.00 to buy the cake, ed)

**NOTICE: THE MEETING THIS MONTH WILL BE OCTOBER 25!!!
A TOUR OF THE HILLCLIMB MUSEUM AND LUNCH
MEET AT DENNY'S AT 9:00AM**



Corvair Society of America

Founded by and for those who still appreciate the Corvair Automobile
P.O. Box 607, Lemont, IL 60439-0607 • 630/257-6530 • fax 257-5540

Membership Application

First Name _____ Last Name _____
 Street Address _____
 City _____ State/Prov. _____ Zip Code _____ Country _____
 Telephone Number (_____) _____ Occupation _____

Fee Schedule

- 1 year membership \$35
- 26 month membership 70
- *1 year Canadian membership 38
- *26 month Canadian membership 76
- *1 year overseas membership 48
- *26 month overseas membership 96
- ____ Corvair Preservation Foundation Donation . min. \$1
- ____ Racing Fund Donation min \$1

Corvair Preservation Foundation



The Corvair Preservation Foundation is established to protect and preserve Corvair memorabilia.

Racing Fund

This fund provides cash prizes to winning Corvairs entered in national open class racing.

*Must be paid in funds drawn on U.S. banks.

to pay by credit card

Circle One    Card No. _____ Expiration Date _____
 Signature _____ Amount _____

Please make check or money order payable to CORSA, Inc. and mail to:
CORSA, Inc., P.O. Box 607, Lemont, IL 60439-0607. Membership includes subscription to the CORSA *Communique*, however there may be a four to six week delay before you receive your first magazine.

CORSA's Board of Directors welcomes you to the Corvair Society of America. To help us better understand your needs and desires, and to aid in charting the direction of future CORSA growth, we request that you take a few moments to answer the following questions.

1. How did you hear about CORSA? _____
2. What is your primary interest in Corvairs? (Transportation, restoration, etc.) _____
3. How many Corvairs do you have? _____ Running _____ Restorable _____ Parts cars _____
4. Are you a long time owner? _____ First time owner? _____ Previous owner who has reacquired a Corvair? _____
5. Approximately how many Corvair-miles do you drive in a year? _____
6. Do you do your own mechanical work? _____ Body work? Major _____ Minor _____
7. What other cars do you own or use for daily transportation? _____
8. What do you hope to gain from membership in CORSA? (Technical information, parts availability, competition information, social information, etc.) _____

CORSA currently has over 130 chapters throughout the world. We encourage membership in our local chapters; if you do not wish to be contacted by a local chapter check the box below. If you already belong to a CORSA chapter, please indicate the chapter number so that we can add it to our records.

Please do not contact a CORSA chapter on my behalf. I belong to CORSA chapter # _____.

Sponsor _____ CORSA ID # _____



UPCOMING EVENTS FOR 1998

OCTOBER 25-----PPCC Tour to the Hilclimb museum and lunch. This is also the meeting for the month. Meet at DENNYs (I-25/Bijou) @ 9:00am. Questions call Larry Neal 570-9694

NOVEMBER 6-8----GWFBT&SM at Palm Springs, Calif. Entry blank in last month's DRIPLINE

NOVEMBER 8-----Second Sunday Brunch at Barrons. Call Larry Neal for reservations

NOVEMBER 18-----PPCC Meeting **NOTICE the time change due to THANKSGIVING**
Meeting location will be the NCOA clubhouse @ 7:30pm

DECEMBER-----Christmas party, gift exchange and elections.

JOIN CORSA ONLY \$35.00/YEAR TO KEEP OUR CARS ALIVE

Kusy's

AUTO TRIM

AUTOMOTIVE AND MARINE UPHOLSTERY



BOAT TOPS & COVERS

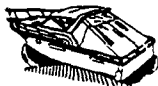

3116 ILLINOIS
COLORADO SPRINGS, CO

MICHAEL KUSY
OWNER

633-8174

From one Corvair lover to another...

CORVAIRS

by

CREATIVE STITCHES
2710 Cancun Court
Grand Junction, CO 81506
(970) 245-4722

MEMBER of CORSA/TUCSON CORVAIR ASS'N
PIKES PEAK CORVAIR CLUB
e-mail mr-mrsvair@juno.com



HERITAGE
REALTORS

GARRIE L. FOX
M.A. RESOURCE MGMT.
BROKER ASSOCIATE
5265 N. Academy Blvd., #3300
Colorado Springs, CO 80918
Office: (719) 548-0400
Fax: (719) 548-9475
Home: (719) 596-5051

S O L D O N C O L O R A D O



FINANCIAL SERVICES

Greg Bianchi
Registered Representative

Investments

- * *Mutual Funds*
- * *Annuities*
- * *IRA's*
- * *Tax Free*
- * *C.D. Alternatives*

Tax Consulting

- * *Business*
- * *Personal*

Life Insurance

- * *Term*
- * *Universal*
- * *Keyman*
- * *Buy / Sell*

Bus: 719-635-7761 WATS 800-366-7935

320 W. Fillmore, Suite 114
Colorado Springs, CO 80907-6065

All Securities Offered Through InterSecurities, Inc.
An Aegon USA Company
Member National Association of Securities Dealers, Inc.
SIPC and SEC Registered Investment Advisor



REAR-ENGINE SPECIALISTS
 16010 W. 5th Ave. Unit 12
 Golden, Colo. 80401



Steve Goodman

(303) 278-4889 Fax (303) 936-7420

INTERSTATE BATTERIES
 INTERSTATE BATTERY SYSTEM OF SOUTHERN COLORADO
 2722 E. CUCHARRAS • COLORADO SPRINGS CO 80903

C. Max Clark
 Owner/Operator

(719) 577-4548
 FAX (719) 578-8114





Service Center

 3930 Encino Dr.
 Colorado Springs, CO 80918

E.L. "Ben" Benzel
 Senior Master Counsellor

Bus.: (719) 599-9725
 Fax: (719) 540-8387
 Res.: (719) 598-6886



AGENT FOR
ACADEMY LIFE
 A PROVIDIAN Insurance Company

WRECKMASTERS
 BODY & FRAME



Jim J. Keeney
 Owner

315 So. 14th St.
 Colorado Springs, CO 80904
 (14th & Cimarron, H-Way 24)

Bus. 520-1184
 Res. 634-7378

Quality Collision Repair & Painting

THE DRIPLINE
 Pikes Peak Corvair Club
 PO Box 15034
 Colorado Springs, Co.
 80935

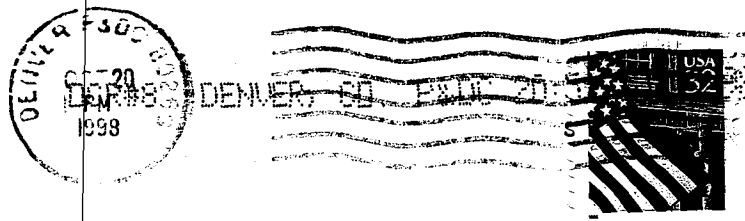

SEND TO:

Walter Hundertmark
 15 El Paso Blvd #26
 Manitou Spgs, Co 80829

88829-2458 02

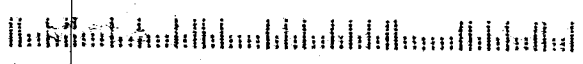

THE

DRIP LINE

VOL. 22
NO. 2 NOVEMBER 1998

**LOOK INSIDE FOR INFORMATION ABOUT THE
CHRISTMAS DINNER PARTY
DECEMBER 16
GET YOUR RESERVATION IN NOW!!!!**

TURNOUT SMALL FOR MUSEUM TOUR

Only 5 CORVAIRs took advantage of free admission to the Hill Climb Museum and drive to Cripple Creek on Sunday October 25. The five cars included Walter Hundertmark/greenbrier, Garrie Fox/66 sedan, Larry Neal/64 coupe, Ben Benzel/62 coupe and Steve and Ruth/62spyder.

As was noted in the OCTOBER issue of the DRIPLINE, all attendees driving CORVAIRs got their museum pass paid for by the club and there were NO BRAND Xs. After looking at the race cars plus all of the pictures and posters, we drove to Cripple Creek for brunch at the Imperial Hotel. The food was very good and for only \$7.00 per person.

Thanks to Larry Neal for doing the set up work on this drive, it is unfortunate that so few PPCC members have chosen to do the last 2 months drives. We have a great time driving our CORVAIRs, see some pretty scenery and enjoying good food as well as each others company.

NOVEMBER MEETING DATE CHANGED

Due to Thanksgiving, the November meeting has been moved up a week to November 18. Your editor will bring some video of the fan belt toss in Palm Springs. Time is 7:30pm as usual in the NCOA Clubhouse. There will also be a discussion of next years' election and hopefully find a way to increase interest in PIKES PEAK CORVAIR CLUB.

A Publication of:



NOTICE

**THE NOVEMBER MEETING WILL
BE NOVEMBER 18
7:30pm AT THE
NCOA CLUBHOUSE**

A Chapter of:



PIKES PEAK CORVAIR CLUB
OFFICERS 1998

PRESIDENT
VICE PRESIDENT
SECRETARY
TREASURER
DRIP LINE EDITOR

LARRY NEAL 570-9694
GARRIE FOX 596-5051
RUTH GOODMAN (303) 934-5027
JOHN KOLL 593-1928
STEVE GOODMAN (303) 934-5027
e-mail rearengine.steve@worldnet.att.net

MEMBERSHIP BEN BENZEL 598-6886
All correspondence To PIKES PEAK CORVAIR CLUB or it's officers should be mailed to PO Box 15034, Colorado Springs, Colo. 80935.

The DRIPLINE is a monthly publication of the PIKES PEAK CORVAIR CLUB, a non-profit organization. Deadline for submitting information to the DRIPLINE is the first Tuesday of each month for that month's publication.

Business card size ads, advertising business services of both members or non-members are \$2.50 per month. To save time and money, advertisers are asked to send \$15.00 for six (6) months or \$30.00 for one year of advertising. Send your advertising check to PIKES PEAK CORVAIR CLUB, INC. PO BOX 15034, COLORADO SPRINGS, COLO. 80935.

Simple classified advertising of CARS FOR SALE or PARTS FOR SALE or WANTED are free to members, non-members will be charged \$2.50 per issue.

NOTES FROM THE PRESIDENT

Greetings all!

Well, we had a light turnout for the Hill Climb Museum and Cripple Creek Brunch. The attendees were Walter Hundertmark in his Greenbrier, Garrie Fox in his 66 Fl 4dr, Ben Benzel in his 62 coupe, Steve and Ruth Goodman in his 62 turbo coupe and myself in my 64 coupe. We all had an enjoyable time but would have been nice to have a few more attendees.

Remember, the November meeting is on the 18th due to THANKSGIVING

Our Christmas dinner will once again be at the County Line at Fillmore and Chestnut on Dec 16. Starting time is 7:30. The dinner will be \$15.95 per person and this includes all-you-can-eat brisket, beef ribs, sausage and chicken, soft drinks, tax and gratuity. Send your reservations and payment to:

Larry Neal
671 Bridger Drive
C/Springs, Colo. 80909 (make checks payable to PPCC)

We will continue the fun tradition of the Yankee gift exchange. Gifts should be \$5.00 or less and marked if gender specific. Participation is option however.

Be thinking about the elections too! The Christmas dinner is our time to elect new officers. Volunteers are always appreciated (thanks Garrie).

We'll see you at the next meeting.

Regards, Larry Neal
President

A TOUCH of CLASS

Professional Detailing

229 N. Cascade, Colorado Springs, CO. 80903

Fine Detailing
At It's Best



*We also specialise in
Classic Antique &
Street Rod Detailing.*

For Appointment call
(719) 448-9313

Michael Wiltrout

Advanced Friction Technologies, Inc.

Manufacturer & Distributor
RK-44 Oil Additive Products



J.B ISAAC
President/C.E.O

3333 C. North El Paso St.
Colorado Springs, CO 80907



(719) 578-5588
Fax (719) 578-9952
(800) TRY-RK44
<http://www.rk44.com>

MAP TO COUNTY LINE RESTAURANT

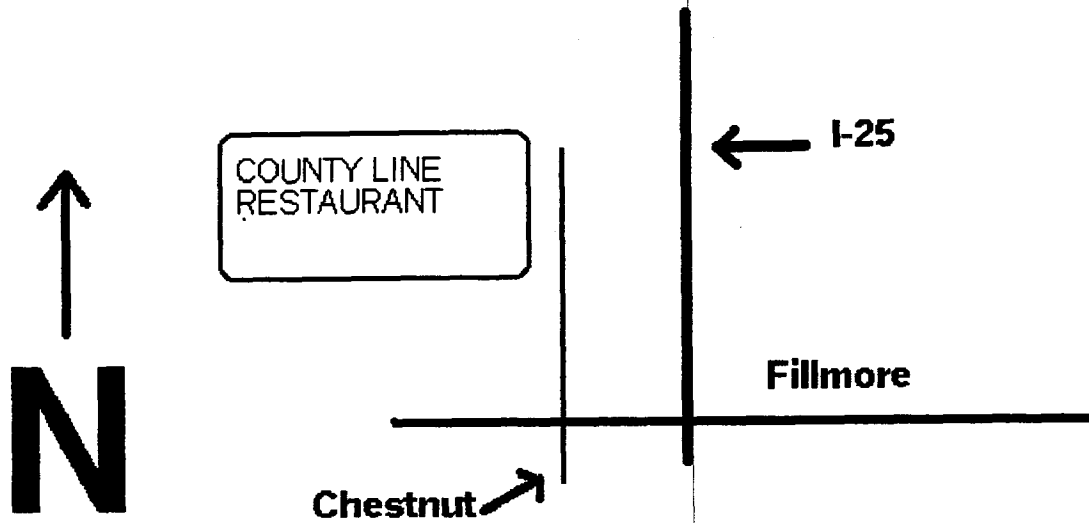

See you there--December 16!!!!



See map above for directions to the **COUNTY LINE RESTAURANT**, December 16 at 7:30pm

Send your checks to:

\$15.95 per person

Larry Neal

671 Bridger Drive

C/Springs, Colo. 80909

Make your checks out to: PIKES PEAK CORVAIR CLUB

Menu includes; Brisket, beef ribs, sausage, chicken plus soft drinks.
Also included for the price of \$15.95 per person is tax and tip.

UPCOMING EVENTS

- NOVEMBER 18-----PPCC meeting **NOTE DATE CHANGE** 7:30pm at the NCOA clubhouse
- DECEMBER 13-----Second Sunday Brunch at BARRONS, 10:00am Call Larry Neal for reservations
- DECEMBER 16-----**CHRISTMAS PARTY** at **COUNTY LINE RESTAURANT** 7:30pm
See stories this issue of the DRIPLINE or call Larry Neal.
- JANUARY 1, 1999-----Brunch with the DENVER CORVAIR CLUB at the STANLEY in Estes Park, Colo. More in the next issue or call Steve

JOIN CORSA ONLY \$35.00/YEAR TO KEEP OUR CARS ALIVE

Kusy's
AUTO TRIM

MICHAEL KUSY
OWNER

AUTOMOTIVE AND MARINE UPHOLSTERY



BOAT TOPS & COVERS



3116 ILLINOIS
COLORADO SPRINGS, CO

633-8174

From one Corvair lover to another...

CORVAIRS

by

CREATIVE STITCHES
2710 Cancun Court
Grand Junction, CO 81506
(970) 245-4722

MEMBER of CORSA/TUCSON CORVAIR ASS'N
PIKES PEAK CORVAIR CLUB
e-mail mr-mrsvair@juno.com



GARRIE L. FOX
M.A. RESOURCE MGMT.
BROKER ASSOCIATE
5265 N. Academy Blvd., #3300
Colorado Springs, CO 80918
Office: (719) 548-0400
Fax: (719) 548-9475
Home: (719) 596-5051

HERITAGE
REALTORS

S O L D O N C O L O R A D O



FINANCIAL SERVICES

Greg Bianchi
Registered Representative

Investments

- * *Mutual Funds*
- * *Annuities*
- * *IRA's*
- * *Tax Free*
- * *C.D. Alternatives*

Tax Consulting

- * *Business*
- * *Personal*

Life Insurance

- * *Term*
- * *Universal*
- * *Keyman*
- * *Buy / Sell*

Bus: 719-635-7761 WATS 800-366-7935

320 W. Fillmore, Suite 114
Colorado Springs, CO 80907-6065

All Securities Offered Through InterSecurities, Inc.
An Aegon USA Company
Member National Association of Securities Dealers, Inc.
SIPC and SEC Registered Investment Advisor

HAPPY THANKSGIVING TO ALL PPCC MEMBERS

MEMBERSHIP AND DUES

The following named members have dues **NOW DUE** or are **PAST DUE!!!** If your name appears below, it is time to get your check to us. Our mailing address is PPCC, PO Box 15034, C/Springs, Colo 80935. Dues are only \$15.00 per year and we need and appreciate your support. Questions, call Ben @ 598-6886.

Garrie Fox**	10/98	Laura Wilshire	11/98
John Glusick**	10/98	Ron Lezon**	10/98
Don Richeson	11/98	Dale Wilshire	12/98
Richard Kennedy	12/98	Mark King	12/98
John Neal	11/98	E. J. Obermeyer	12/98
Ed Olwine	12/98	Don Smith	12/98

****DENOTES PAST DUE!!!**

Please remit your dues quickly, THANK YOU!!!

Ben Benzel, membership chairman

CHRISTMAS IDEAS

Christmas shopping can be a chore, here are a few helpful hints for the CORVAIR owner, or just any owner of a collector car or even just the family car in some cases. Actually these are hints for the CORVAIR owners wife!!!!

TOOLS: Small tools such as a 'fitting wrench' for fuel lines, a carb synchronizer (Uni-syn), a timing lite, a small volt/ohm meter (also known as a multi-tester by places like RADIO SHACK) a good trouble lite (one of the florescent type is better these days), a good magnet to reach that part that dropped way down inside the sheet metal, well you get the idea, something small.

BOOKS: There are several advertised book retailers such as **CLASSIC MOTORBOOKS** that have books for each car make, how-to books for restoring body/engine/interior, books to help you shop for that next special car, books to help make your car handle better and videos of everything from racing to instruction of how to rebuild your transmission. ALSO there is a local bookstore called **COLORADO CAR BOOKS** in the shopping center at Bellvue and Broadway in Englewood that has books on every kind of car. He also keeps the shop manuals and various publications of our favorite car the CORVAIR.

APPAREL: Look in **WALLS** catalog (he advertises in the DRIPLINE) and you will find t-shirts, jacket patches, jackets, belt buckles and more. There are tie tacks, earrings, and hats too.

CLUB AFFILIATIONS: Give a membership to CORSA. The COMMUNIQUE alone is worth the price. In addition, give a membership to PPCC and CORSA to someone you know of who has a CORVAIR and does not belong to our club.

MERRY CHRISTMAS



Corvair Society of America

Founded by and for those who still appreciate the Corvair Automobile
P.O. Box 607, Lemont, IL 60439-0607 • 630/257-6530 • fax 257-5540

Membership Application

First Name _____ Last Name _____

Street Address _____

City _____ State/Prov. _____ Zip Code _____ Country _____

Telephone Number (_____) _____ Occupation _____

Fee Schedule

- 1 year membership \$35
- 26 month membership 70
- *1 year Canadian membership 38
- *26 month Canadian membership 76
- *1 year overseas membership 48
- *26 month overseas membership 96
- ____ Corvair Preservation Foundation Donation . min. \$1
- ____ Racing Fund Donation min \$1

Corvair Preservation Foundation



The Corvair Preservation Foundation is established to protect and preserve Corvair memorabilia.

Racing Fund

This fund provides cash prizes to winning Corvairs entered in national open class racing.

*Must be paid in funds drawn on U.S. banks.

to pay by credit card

Circle One   	Card No. _____	Expiration Date _____
Signature _____	Amount _____	

Please make check or money order payable to CORSA, Inc. and mail to: CORSA, Inc., P.O. Box 607, Lemont, IL 60439-0607. Membership includes subscription to the CORSA *Communique*, however there may be a four to six week delay before you receive your first magazine.

CORSA's Board of Directors welcomes you to the Corvair Society of America. To help us better understand your needs and desires, and to aid in charting the direction of future CORSA growth, we request that you take a few moments to answer the following questions.

- How did you hear about CORSA? _____
- What is your primary interest in Corvairs? (Transportation, restoration, etc.) _____
- How many Corvairs do you have? _____ Running _____ Restorable _____ Parts cars _____
- Are you a long time owner? _____ First time owner? _____ Previous owner who has reacquired a Corvair? _____
- Approximately how many Corvair-miles do you drive in a year? _____
- Do you do your own mechanical work? _____ Body work? Major _____ Minor _____
- What other cars do you own or use for daily transportation? _____
- What do you hope to gain from membership in CORSA? (Technical information, parts availability, competition information, social information, etc.) _____

CORSA currently has over 130 chapters throughout the world. We encourage membership in our local chapters; if you do not wish to be contacted by a local chapter check the box below. If you already belong to a CORSA chapter, please indicate the chapter number so that we can add it to our records.

Please do not contact a CORSA chapter on my behalf. I belong to CORSA chapter # _____.

Sponsor _____ CORSA ID # _____



MEETING MINUTES

There was no meeting held in October, 1998. The only members present for a meeting on October 25 were President, Larry Neal-Vice President, Garrie Fox-Secretary, Ruth Goodman-Dripline editor, Steve Goodman-Membership chairman, Ben Benzel and past OCC Representative Walter Hundertmark. The meeting would have been held at the brunch at the Imperial Hotel in Cripple Creek if there would have been a quorum.

TECH SESSION AT REAR ENGINE SPECIALISTS

Rear Engine Specialists, Inc will host a tech session on November 21. This is the monthly activity for RMC (Denver) but PPCC members are welcome to attend. The program will be checking the tailpipe emissions of all cars present, just like you get your actual test at one of the test centers. I will be happy to do a 'screwdriver' adjustment of any car not in compliance if desired by the owner, however beyond that I can only make recommendations as to what it would take to bring the car into compliance. Any adjustment will be free of charge.

In addition, to help pass the time and provide a little entertainment, there will be a contest to see who can guess which car will have the cleanest readings. This guess will be done before any testing begins of course. The cost of each guess will be \$2.00, of which 1.00 will go to the RMC club treasury, the other dollar will go into a pot to be claimed by the winning guess. In case of a tie the pot will be split between all those who guessed the winning car. You may guess as many times as you wish for \$2.00 per guess.

The testing will begin at 9:00am, all guesses must be in before that time. After all of this fun, lunch will be at Jacksons on 6th and Kipling in the 12:30pm range.

DISCLAIMER--if the weather is cold, below about 25 degrees, the machine will not function properly and the cars will need a warmup before testing too. If that happens, there will be a tech program inside the shop, subject: I will have to wing it I guess!!!!

WE'RE YOUR
DISCOUNT
CORVAIR PARTS
FOR THE 90'S AND BEYOND!



SERVICE
SELECTION
SATISFACTION
SIMPLE!

FOR 23 YEARS WE'VE BEEN SUPPLYING CORVAIR OWNERS WITH THE PARTS THEY NEED - ALL AT THE BEST DISCOUNT PRICES! REPRODUCED PARTS, USED PARTS, REBUILDING SERVICES - WE HAVE IT ALL! BEFORE YOU BUY MAKE SURE TO CHECK US OUT - 30 DAY NO-RESTOCKING, ONE YEAR GUARANTEE ON MOST PARTS AND SERVICES. FAST, SAME DAY SERVICE. ALL MAJOR CREDIT CARDS ACCEPTED. TOLL FREE ORDER NUMBER (1-800-825-8247). GIANT SELECTION!

ORDER OUR GIANT MAIL ORDER CATALOG - THE CORVAIR BOOK - \$5.00 NOW REFUNDABLE WITH FIRST ORDER OF \$100.00 OR MORE!

ALSO MAKE SURE YOU'RE ON OUR SUBSCRIPTION LIST FOR OUR FREE NEWSLETTER - THE CORVAIR NEWS WE NEED YOUR NAME & ADDRESS!

CORVAIR UNDERGROUND INC.
PO BOX 339 DUNDEE, OR 97115
1-503-434-1648 9-5 M-F
FAX 1-503-434-1648
WWW.CORVAIRUNDERGROUND.COM

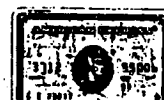



REAR-ENGINE SPECIALISTS
 16010 W. 5th Ave. Unit 12
 Golden, Colo. 80401



Steve Goodman

(303) 278-4889 Fax (303) 936-7420

INTERSTATE BATTERIES
 INTERSTATE BATTERY SYSTEM OF SOUTHERN COLORADO
 222 E. CUCHARRAS • COLORADO SPRINGS CO 80903

C. Max Clark
 Owner/Operator

(719) 577-4548
 FAX (719) 578-8114





Service Center

 3930 Encino Dr.
 Colorado Springs, CO 80918

E.L. "Ben" Benzel
 Senior Master Counsellor

Bus.: (719) 599-9725
 Fax: (719) 540-8387
 Res.: (719) 598-6886



AGENT FOR
ACADEMY LIFE
 A PROVIDIAN Insurance Company

WRECKMASTERS
 BODY & FRAME

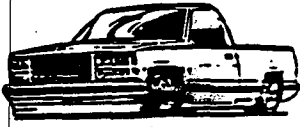

Jim J. Keeney
 Owner

315 So. 14th St.
 Colorado Springs, CO 80904
 (14th & Cimarron. H-Way 24)

Bus. 520-1184
 Res. 634-7378

Quality Collision Repair & Painting

THE DRIPLINE
 Pikes Peak Corvair Club
 PO Box 15034
 Colorado Springs, Co.
 80935

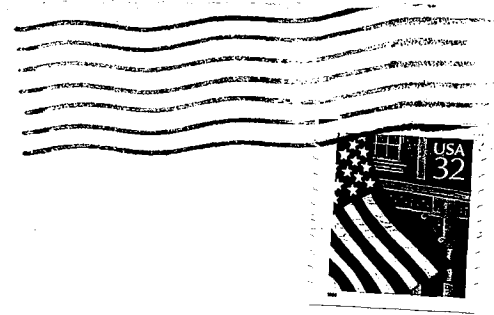

SEND TO:

Walter Hundertmark
 15 El Paso Blvd #26
 Manitou Spgs, Co 80829

80829-2456 02

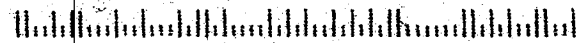

THE

DRIP LINE

VOL. 22

NO. 3 DECEMBER 1998

HAPPY HOLIDAYS

to all PPCC members and their families
and a

GREAT 1999!!!

CHRISTMAS DINNER AND GIFT EXCHANGE

The annual **CHRISTMAS PARTY** will be held on December 16th at 7:30 pm at the **COUNTY LINE RESTAURANT**. There is a map inside to help you find your way. This is the last event for PPCC in 1998 and hopefully you will all decide to attend.

Along with the dinner there will be the election of officers for 1999. Garrie Fox has volunteered to take over the presidential duties, Larry Neal has done a fine job for several years now and wants to retire gracefully. There is an opening for the VP job and we need someone to step forward and offer to take this position. The rest of the officers are willing to continue another year, however if someone would like a job, they can certainly be nominated.

After the dinner and elections, the yankee gift exchange will take place. It is a lot of fun and the rules are better left for the night of the dinner. Everyone wishing to participate should bring one gift each with a value of \$5.00 or so and mark it 'boy' 'girl' or 'either'.

Please contact Larry Neal before December 12 with your reservations. His phone number is: 570-9694. Larry MUST have a head count by the 12th. Please try to attend this event.

A Publication of:

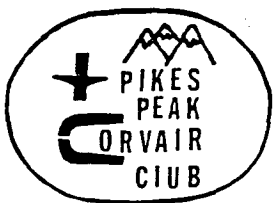

NOTICE

THE DECEMBER MEETING WILL
BE DECEMBER 16
7:30PM AT THE
COUNTY LINE RESTAURANT

A Chapter of:



PIKES PEAK CORVAIR CLUB
OFFICERS 1998

PRESIDENT
VICE PRESIDENT
SECRETARY
TREASURER
DRIP LINE EDITOR

LARRY NEAL 570-9694
GARRIE FOX 596-5051
RUTH GOODMAN (303) 934-5027
JOHN KOLL 593-1928
STEVE GOODMAN (303) 934-5027
e-mail reafengine.steve@worldnet.att.net
BEN BENZEL 598-6886

MEMBERSHIP

All correspondence To PIKES PEAK CORVAIR CLUB or it's officers should be mailed to PO Box 15034, Colorado Springs, Colo. 80935.

The DRIPLINE is a monthly publication of the PIKES PEAK CORVAIR CLUB, a non-profit organization. Deadline for submitting information to the DRIPLINE is the first Tuesday of each month for that month's publication.

Business card size ads, advertising business services of both members or non-members are \$2.50 per month. To save time and money, advertisers are asked to send \$15.00 for six (6) months or \$30.00 for one year of advertising. Send your advertising check to PIKES PEAK CORVAIR CLUB, INC. PO BOX 15034, COLORADO SPRINGS, COLO. 80935.

Simple classified advertising of CARS FOR SALE or PARTS FOR SALE or WANTED are free to members, non-members will be charged \$2.50 per issue.

GREETINGS AND HAPPY HOLIDAYS EVERYONE

Well, we all really enjoyed Steve Goodman's video of the Fan Belt Toss. Another excellent Miracle Production! Thanks Steve. Not too much going on here at the end of the year, but keep in mind our elections for new club officers will be at the Christmas Dinner meeting. Volunteers for V-President and Secretary would be nice. Come to the Christmas meeting to vote and volunteer. As a reminder, the meeting will be on **WEDNESDAY**, the **16th** at 7:30pm at the **COUNTY LINE RESTAURANT** and the cost is \$15.95 per person for everything but the bar. We will also be having the yankee gift exchange for all who want to participate, with a gift of about \$5.00 labeled boy, girl, or either. Let me know if you are able to attend.

As outgoing President, I would like to thank all of our members for the support and friendship you've given me these past years. I specifically want to thank **Ben Benzel** for the use of his clubhouse and all the recruiting he has done for us, **John Koll** for watching our financial situation year after year and hauling/storing the club display, Steve Goodman for putting out the **DRIPLINE**, attending every meeting and event, helping us with our Vairs and generally being an allround nice guy. A **BIG THANKYOU** to **Ruth Goodman** who volunteered to be secretary in 1998 AND brings down the delicious cakes and goodies every month! Finally, thanks to Garrie Fox for being VP and taking of the presidency for me. I'm sure he'll bring some fresh ideas and get all our support. I've enjoyed these past years and look forward to many more with all my CORVAIR friends! **THANK YOU!!**

See you at the COUNTY LINE
Larry A. Neal

THE NAME HAS CHANGED

Tri-State Auto Exhibition becomes 'All West Auto Fest' for 1999. The show's ownership and management remains unchanged. The Sabers Auto Club has been putting the show together for 42 years now and will continue to do so in the new millenium. Show will be at Currigan Hall on March 18-21, 1999.

Ben Benzel, membership chairman

A TOUCH of CLASS

Professional Detailing

229 N. Cascade, Colorado Springs, CO. 80903

Fine Detailing
At R's Best



*We also specialized in
Classic Antiques &
Street Rod Detailing.*

For Appointment call
(719) 448-9313

Michael Wiltrout

Advanced Friction Technologies, Inc.

Manufacturer & Distributor
RK-44 Oil Additive Products



J.B ISAAC
President/C.E.O



3333 C. North El Paso St.
Colorado Springs, CO 80907

(719) 578-5588
Fax (719) 578-9952
(800) TRY-RK44
<http://www.rk44.com>

MAP TO COUNTY LINE RESTAURANT

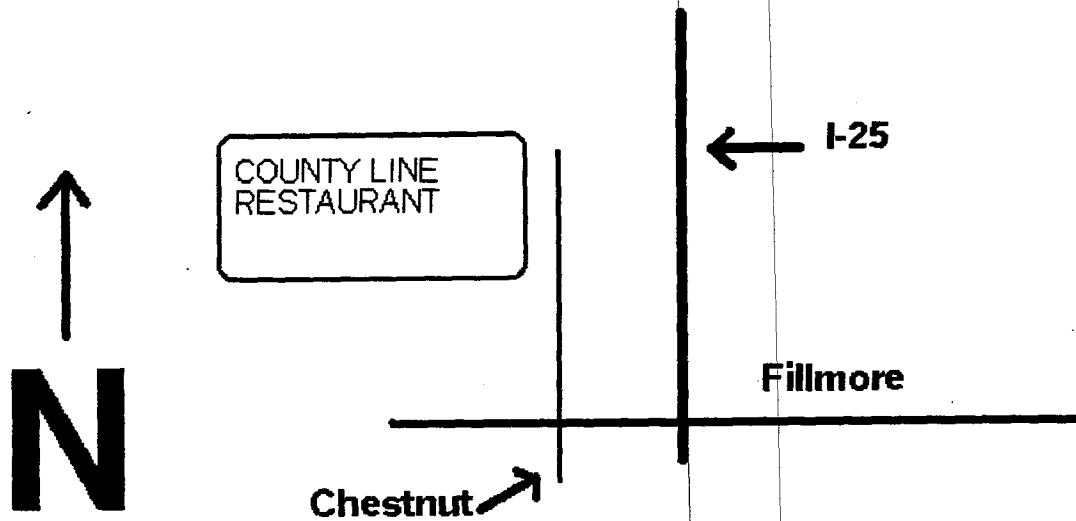

See you there--December 16!!!!



See map above for directions to the **COUNTY LINE RESTAURANT**, December 16 at 7:30pm

Send your checks to:

\$15.95 per person

Larry Neal
671 Bridger Drive
C/Springs, Colo. 80909

Make your checks out to: **PIKES PEAK CORVAIR CLUB**

Menu includes; Brisket, beef ribs, sausage, chicken plus soft drinks.
Also included for the price of \$15.95 per person is tax and tip.

UPCOMING EVENTS

DECEMBER 12-----Second Sunday brunch at BARRONS. 10:00am. Call Larry Neal for reservations, 570-9694

DECEMBER 16-----ANNUAL CHRISTMAS PARTY, DINNER AND GIFT EXCHANGE PLUS ELECTIONS at the COUNTY LINE RESTAURANT 7:30pm
Call Larry Neal for reservations by DECEMBER 12

JANUARY 1, 1999-----Brunch with RMC (DENVER) at the Stanley Hotel in Estes Park.
See story this issue of the DRIPLINE

JANUARY 10, 1999-----Second Sunday brunch at Barrons. 10:00am

JANUARY 27, 1999-----MONTHLY MEETING OF PPCC at the CLUBHOUSE 7:30pm

JOIN CORSA ONLY \$35.00/YEAR TO KEEP OUR CARS ALIVE

Kusy's

AUTO TRIM

MICHAEL KUSY
OWNER

AUTOMOTIVE AND MARINE UPHOLSTERY



BOAT TOPS & COVERS



3116 ILLINOIS
COLORADO SPRINGS, CO

633-8174

From one Corvair lover to another...

CORVAIRS

by
CREATIVE STITCHES
2710 Cancun Court
Grand Junction, CO 81506
(970) 245-4722

MEMBER of CORSA/TUCSON CORVAIR ASS'N
PIKES PEAK CORVAIR CLUB
e-mail mr-mrsvair@juno.com

GARRIE L. FOX
M.A. RESOURCE MGMT.
BROKER ASSOCIATE
5265 N. Academy Blvd. #3300
Colorado Springs, CO 80918
Office: (719) 548-0400
Fax: (719) 548-9475
Home: (719) 596-5051



HERITAGE
REALTORS

SOLD ON COLORADO



FINANCIAL SERVICES

Greg Bianchi
Registered Representative

Investments

- * *Mutual Funds*
- * *Annuities*
- * *IRA's*
- * *Tax Free*
- * *C.D. Alternatives*

Tax Consulting

- * *Business*
- * *Personal*

Life Insurance

- * *Term*
- * *Universal*
- * *Keyman*
- * *Buy / Sell*

Bus: 719-635-7761 WATS 800-366-7935

320 W. Fillmore, Suite 114
Colorado Springs, CO 80907-6065

All Securities Offered Through InterSecurities, Inc.
An Aegon USA Company
Member National Association of Securities Dealers, Inc.
SIPC and SEC Registered Investment Advisor

NEW YEARS DAY DRIVE

ROCKY MOUNTAIN CORSA in Denver has had a tradition since the beginning of the club in 1972 to drive to the mountains for brunch on **NEW YEARS DAY**. For many years the drive was either to Georgetown or Idaho Springs but the locale has shifted the last couple of years. The restaurants in the mountain towns west of Denver are either closed on New Years Day or they cannot (or will not) accomodate a large group, especially if the count is unknown till the very last minute.

Last year RMC went to the famed **STANLEY HOTEL** in Estes Park. The food and service were very good and RMC decided to return there on January 1, 1999.

PPCC members are invited to attend, Laura Wilshire who is the President of RMC and also a member of PPCC, must have your money in her hand by December 26. The amount is \$20.00 per person and that includes tip and tax. Due to the fact that the **STANLEY** is really popular on New Years Day, it is imperative that an exact count be taken by the 26th, therefore there will be no last minute arrivals permitted. If you have not paid Laura by the 26th, the hotel will not have a table and chair available.

Laura will be at the Christmas party at the **COUNTY LINE** also, you may pay her at that time. In fact she will probably be asked to say a few words about upcoming RMC events also.

PPCC has members living in Estes Park also, Marsh and Carole Hesler. They should also be in attendance at the Stanley.

MEMBERSHIP AND DUES

The following named members have dues **NOW DUE** or are **PAST DUE!!!** If your name appears below, it is time to get your check to us. So, bring your check to the **CHRISTMAS DINNER PARTY** on December 16th or if you can't attend, please mail it to PPCC, PO BOX 15034, C/Springs, Co. 80935. Dues are \$15.00 per year and we need and appreciate your support. Questions, call Ben@ 598-6886.

GARRIE FOX***	10/98	Terry McKenna	1/99
Steve Goodman	1/99	John Neal	11/98
Richard Kennedy	12/98	E. J. Obermeyer	12/98
Mark King	12/98	Ed Olwine	12/98
Richard King	1/99	Don Smith	12/98
RON LEZON***	10/98	Don Vinson	1/99
Dale Wilshire	12/98	Laura Wilshire	11/98

*****DENOTES FINAL NOTICE!!!** This is your last issue of the famous **DRIPLINE**. Please remit your dues ASAP. Thank you.

Happy Holidays

Ben Benzel, membership chairman

CLEANEST TAIL PIPE CONTEST

A sunny day greeted those who attended the tech session at Rear Engine in Golden on November 21. There were 11 **CORVAIRS** in attendance, everything from a 1963 Monza to a Crown v-8. The cleanest tail pipe was Darryl Jacksons 64 Monza, 95hp/3spd. There were a couple of cars that were badly out of adjustment but only a screwdriver, uni-syn and timing light were needed to easily bring the cars into compliance. Hopefully those watching were able to understand a little more about what is entailed to adjust an engine for passing the emission test.

Afterward the group drove to **JACKSON'S** for lunch.



Corvair Society of America

Founded by and for those who still appreciate the Corvair Automobile
P.O. Box 607, Lemont, IL 60439-0607 • 630/257-6530 • fax 257-5540

Membership Application

First Name _____ Last Name _____
 Street Address _____
 City _____ State/Prov. _____ Zip Code _____ Country _____
 Telephone Number (_____) _____ Occupation _____

Fee Schedule

- 1 year membership \$35
- 26 month membership 70
- *1 year Canadian membership 38
- *26 month Canadian membership 76
- *1 year overseas membership 48
- *26 month overseas membership 96
- ____ Corvair Preservation Foundation Donation . min. \$1
- ____ Racing Fund Donation min \$1

Corvair Preservation Foundation



The Corvair Preservation Foundation is established to protect and preserve Corvair memorabilia.

Racing Fund

This fund provides cash prizes to winning Corvairs entered in national open class racing.

*Must be paid in funds drawn on U.S. banks.

to pay by
credit card

Circle One   	Card No. _____	Expiration Date _____
Signature _____	Amount _____	

Please make check or money order payable to CORSA, Inc. and mail to: CORSA, Inc., P.O. Box 607, Lemont, IL 60439-0607. Membership includes subscription to the CORSA *Communique*, however there may be a four to six week delay before you receive your first magazine.

CORSA's Board of Directors welcomes you to the Corvair Society of America. To help us better understand your needs and desires, and to aid in charting the direction of future CORSA growth, we request that you take a few moments to answer the following questions.

- How did you hear about CORSA? _____
- What is your primary interest in Corvairs? (Transportation, restoration, etc.) _____
- How many Corvairs do you have? _____ Running _____ Restorable _____ Parts cars _____
- Are you a long time owner? _____ First time owner? _____ Previous owner who has reacquired a Corvair? _____
- Approximately how many Corvair-miles do you drive in a year? _____
- Do you do your own mechanical work? _____ Body work? Major _____ Minor _____
- What other cars do you own or use for daily transportation? _____
- What do you hope to gain from membership in CORSA? (Technical information, parts availability, competition information, social information, etc.) _____

CORSA currently has over 130 chapters throughout the world. We encourage membership in our local chapters; if you do not wish to be contacted by a local chapter check the box below. If you already belong to a CORSA chapter, please indicate the chapter number so that we can add it to our records.

Please do not contact a CORSA chapter on my behalf. I belong to CORSA chapter # _____

Sponsor _____ CORSA ID # _____

MEETING MINUTES

The November meeting of PPCC was held at the clubhouse on the 18th. It was moved ahead a week due to the Thanksgiving holiday. The meeting was called to order by President Larry Neal at 7:35pm. There were 12 present including guests Michael and Orita Wiltrout. The Wiltrouts are the proud new owners of a 1963 Monza coupe and were recruited by Garrie Fox. They also own 'A TOUCH OF CLASS' detailing shop that advertises in the DRIPLINE.

The outing to the Hill climb museum and drive to Cripple Creek was discussed for old business. The upcoming Christmas party was also discussed. The party is the 16th of December, cost is \$15.95 per person and that includes tip and tax. Larry stated that he needed a pretty firm head count by December 12. ELECTIONS were also talked about, the job of VP is open however there was a rumor that Ken Brown might be interested in that position. The other positions seem filled with Garrie Fox having a desire to be the president, Ruth will stay on as secretary if need be, John Koll will continue to be treasurer and Steve Goodman will be the DRIPLINE editor for another year. However it was noted that if someone wanted to run against any of those officers, they certainly have the opportunity to do so at the party.

For entertainment, Steve brought a video of the fan belt toss in Palm Springs that he and Ruth attended in early November. Door prizes were drawn and the meeting was adjourned at 9:05. Ruth Goodman was not present but her dessert was, thank you Ruth for the great cake.

Respectfully submitted, Steve Goodman for
Ruth Goodman, secretary

1999 should be a great year. Please try to attend the meetings and events and support PPCC through the year. Support CORSA by joining and planning to attend the national convention, held in 1999 in Lake Tahoe. The TRI-STATE is in Salida in early June.

WE'RE YOUR
DISCOUNT
CORVAIR PARTS
FOR THE 90'S AND BEYOND!



SERVICE
SELECTION
SATISFACTION
SIMPLE!



FOR 23 YEARS WE'VE BEEN SUPPLYING CORVAIR OWNERS WITH THE PARTS THEY NEED - ALL AT THE BEST DISCOUNT PRICES! REPRODUCED PARTS, USED PARTS, REBUILDING SERVICES - WE HAVE IT ALL! BEFORE YOU BUY MAKE SURE TO CHECK US OUT - 30 DAY NO-RESTOCKING, ONE YEAR GUARANTEE ON MOST PARTS AND SERVICES. FAST, SAME DAY SERVICE. ALL MAJOR CREDIT CARDS ACCEPTED. TOLL FREE ORDER NUMBER (1-800-825-8247). GIANT SELECTION!

ORDER OUR GIANT MAIL ORDER CATALOG - THE CORVAIR BOOK - \$5.00 NOW REFUNDABLE WITH FIRST ORDER OF \$100.00 OR MORE!

ALSO MAKE SURE YOU'RE ON OUR SUBSCRIPTION LIST FOR OUR FREE NEWSLETTER - THE CORVAIR NEWS WE NEED YOUR NAME & ADDRESS!

CORVAIR UNDERGROUND INC
PO BOX 339 DUNDEE, OR 97115
1-503-434-1648 9-5 M-F
FAX 1-503-434-1648
WWW.CORVAIRUNDERGROUND.COM



REAR-ENGINE SPECIALISTS
 16010 W. 5th Ave. Unit 12
 Golden, Colo. 80401

Steve Goodman



(303) 278-4889 Fax (303) 936-7420



INTERSTATE BATTERY SYSTEM OF SOUTHERN COLORADO
 222 E. CUCHARRAS - COLORADO SPRINGS CO 80903

C. Max Clark
 Owner/Operator

(719) 577-4548
 FAX (719) 578-8114

NCOA

Service Center

 3930 Encino Dr.
 Colorado Springs, CO 80918

E.L. "Ben" Benzel
 Senior Master Counsellor

Bus.: (719) 599-9725
 Fax: (719) 540-8387
 Res.: (719) 598-6886



AGENT FOR
ACADEMY LIFE
 A PROVIDIAN Insurance Company

WRECKMASTERS
 BODY & FRAME

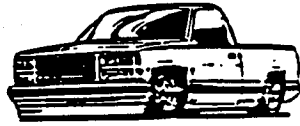

Jim J. Keeney
 Owner

315 So. 14th St.
 Colorado Springs, CO 80904
 (14th & Cimarron, H-Way 24)

Bus. 520-1184
 Res. 634-7378

Quality Collision Repair & Painting

THE DRIPLINE
 Pikes Peak Corvair Club
 PO Box 15034
 Colorado Springs, Co.
 80935



SEND TO:

Walter Hundertmark
 15 El Paso Blvd #26
 Manitou Spgs, Co 80829